

TMC2209 Datasheet

Step/Dir Drivers for Two-Phase Bipolar Stepper Motors up to 2.8A peak – StealthChop™ for Quiet Movement – UART Interface Option – Sensorless Stall Detection StallGuard4.

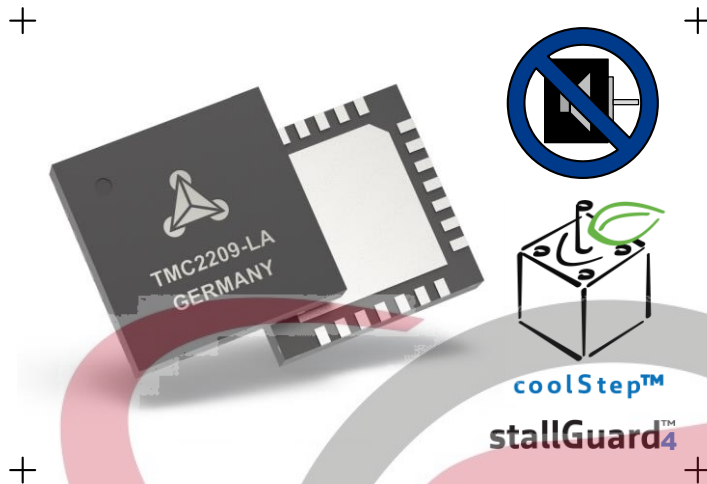

- APPLICATIONS**
- Compatible Design Upgrade
 - 3D Printers
 - Printers, POS
 - Office and home automation
 - Textile, Sewing Machines
 - CCTV, Security
 - ATM, Cash recycler
 - HVAC
 - Battery Operated Equipment

FEATURES AND BENEFITS

- 2-phase** stepper motors up to 2.8A coil current (peak), 2A RMS
- STEP/DIR Interface** with 8, 16, 32 or 64 microstep pin setting
- Smooth Running** 256 microsteps by **MicroPlyer™** interpolation
- StealthChop2™** silent motor operation
- SpreadCycle™** highly dynamic motor control chopper
- StallGuard4™** load and stall detection for StealthChop
- CoolStep™** current control for energy savings up to 75%
- Low RDSon, Low Heat-Up** LS 170mΩ & HS 170mΩ (typ. at 25°C)
- Voltage Range** 4.75... 29V DC
- Low Power Standby** to fit standby energy regulations
- Internal Sense Resistor** option (no sense resistors required)
- Passive Braking**, Freewheeling, and automatic power down
- Single Wire UART & OTP** for advanced configuration options
- Integrated Pulse Generator** for standalone motion
- Full Protection & Diagnostics**
- Compact QFN package** with large heat slug

DESCRIPTION

The TMC2209 is an ultra-silent motor driver IC for two phase stepper motors. TMC2209 pinning is compatible to a number of legacy drivers as well as to the TMC2208. TRINAMICs sophisticated StealthChop2 chopper ensures noiseless operation, maximum efficiency and best motor torque. Its fast current regulation and optional combination with SpreadCycle allow highly dynamic motion while adding. StallGuard for sensorless homing. The integrated power MOSFETs handle motor currents up to 2A RMS with protection and diagnostic features for robust and reliable operation. A simple to use UART interface opens up tuning and control options. Store application tuning to OTP memory. Industries' most advanced STEP/DIR stepper motor driver family upgrades designs to noiseless and most precise operation for cost-effective and highly competitive solutions.

BLOCK DIAGRAM

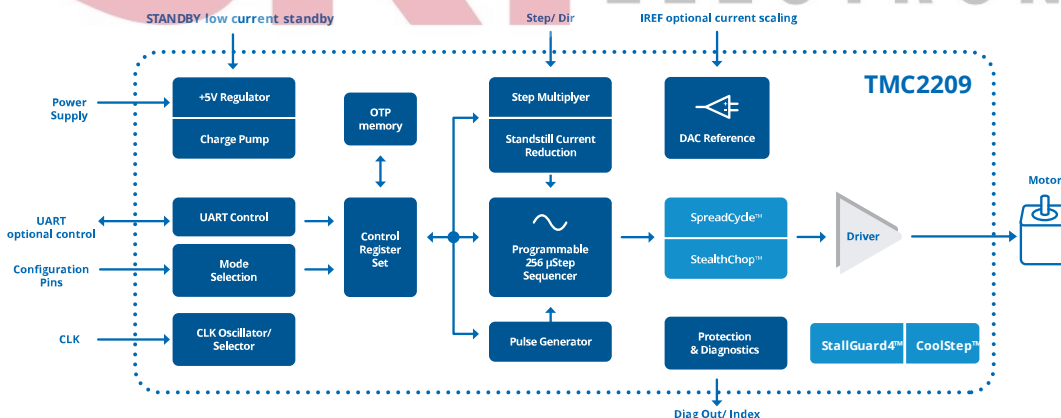

APPLICATION EXAMPLES: SIMPLE SOLUTIONS – HIGHLY EFFECTIVE

The TMC22xx family scores with power density, integrated power MOSFETs, smooth and quiet operation, and a congenial simplicity. The TMC2209 covers a wide spectrum of applications from battery systems to embedded applications with up to 2A motor current per coil. TRINAMICs unique chopper modes SpreadCycle and StealthChop2 optimize drive performance. StealthChop reduces motor noise to the point of silence at low velocities. Standby current reduction keeps costs for power dissipation and cooling down. Extensive support enables rapid design cycles and fast time-to-market with competitive products.

STANDALONE REPLACEMENT FOR LEGACY STEPPER DRIVER

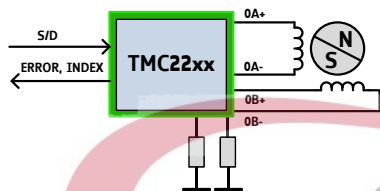

In this example, configuration is hard wired via pins. Software based motion control generates STEP and DIR (direction) signals, INDEX and ERROR signals report back status information.

UART INTERFACE FOR FULL DIAGNOSTICS AND CONTROL

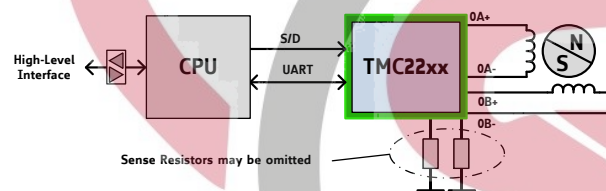

A CPU operates the driver via step and direction signals. It accesses diagnostic information and configures the TMC2209 via the UART interface. The CPU manages motion control and the TMC2209 drives the motor and smoothens and optimizes drive performance.

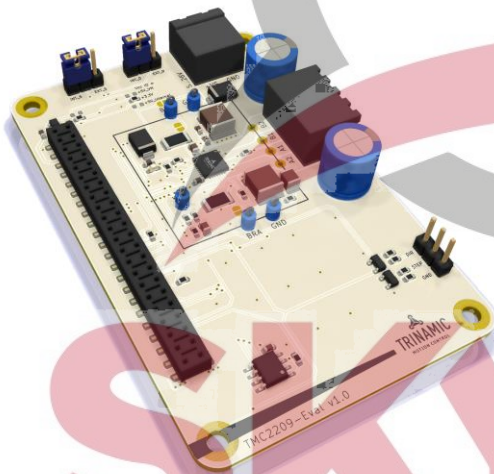

The TMC2209-EVAL is part of TRINAMICs universal evaluation board system which provides a convenient handling of the hardware as well as a user-friendly software tool for evaluation. The TMC2209 evaluation board system consists of three parts: STARTRAMPE (base board), ESELSBRÜCKE (connector board with several test points and stand-alone settings), and TMC2209-EVAL.

ORDER CODES

Order code	PN	Description	Size [mm ²]
TMC2209-LA	00-0173	StealthChop standalone driver; QFN28 (RoHS compliant)	5 x 5
TMC2209-LA-T	00-0173-T	-T denotes tape on reel packing of devices	
TMC2209-EVAL	40-0169	Evaluation board for TMC2209 stepper motor driver	85 x 55
ESELSBRÜCKE	40-0098	Connector board fitting to Landungsbrücke	61 x 38
LANDUNGSBRÜCKE	40-0167	Baseboard for TMC2209-EVAL & further evaluation boards	85 x 55

Table of Contents

1	PRINCIPLES OF OPERATION	4	9.1	ANALOG CURRENT SCALING VREF	51
1.1	KEY CONCEPTS	5	10	INTERNAL SENSE RESISTORS	53
1.2	CONTROL INTERFACES	6	11	STALLGUARD₄ LOAD MEASUREMENT	55
1.3	MOVING AND CONTROLLING THE MOTOR	6	11.1	STALLGUARD ₄ VS. STALLGUARD ₂	55
1.4	STEALTHCHOP ₂ & SPREADCYCLE DRIVER	6	11.2	TUNING STALLGUARD ₄	56
1.5	STALLGUARD ₄ – MECHANICAL LOAD SENSING	7	11.3	STALLGUARD ₄ UPDATE RATE	56
1.6	COOLSTEP – LOAD ADAPTIVE CURRENT CONTROL	7	11.4	DETECTING A MOTOR STALL	56
1.7	AUTOMATIC STANDSTILL POWER DOWN	8	11.5	LIMITS OF STALLGUARD ₄ OPERATION	56
1.8	INDEX OUTPUT	8	12	COOLSTEP OPERATION	57
1.9	PRECISE CLOCK GENERATOR AND CLK INPUT	8	12.1	USER BENEFITS	57
2	PIN ASSIGNMENTS	9	12.2	SETTING UP FOR COOLSTEP	57
2.1	PACKAGE OUTLINE TMC2209	9	12.3	TUNING COOLSTEP	59
2.2	SIGNAL DESCRIPTIONS TMC2209	9	13	STEP/DIR INTERFACE	60
3	SAMPLE CIRCUITS	11	13.1	TIMING	60
3.1	STANDARD APPLICATION CIRCUIT	11	13.2	CHANGING RESOLUTION	61
3.2	INTERNAL R _{DS(on)} SENSING	11	13.3	MICROPLYER STEP INTERPOLATOR AND STAND STILL DETECTION	62
3.3	5V ONLY SUPPLY	12	13.4	INDEX OUTPUT	63
3.4	CONFIGURATION PINS	13	14	INTERNAL STEP PULSE GENERATOR	64
3.5	HIGH MOTOR CURRENT	13	15	DRIVER DIAGNOSTIC FLAGS	65
3.6	LOW POWER STANDBY	14	15.1	TEMPERATURE MEASUREMENT	65
3.7	DRIVER PROTECTION AND EME CIRCUITRY	14	15.2	SHORT PROTECTION	65
4	UART SINGLE WIRE INTERFACE	15	15.3	OPEN LOAD DIAGNOSTICS	66
4.1	DATAGRAM STRUCTURE	15	15.4	DIAGNOSTIC OUTPUT	66
4.2	CRC CALCULATION	17	16	QUICK CONFIGURATION GUIDE	67
4.3	UART SIGNALS	17	17	EXTERNAL RESET	71
4.4	ADDRESSING MULTIPLE SLAVES	18	18	CLOCK OSCILLATOR AND INPUT	71
5	REGISTER MAP	19	19	ABSOLUTE MAXIMUM RATINGS	72
5.1	GENERAL REGISTERS	20	20	ELECTRICAL CHARACTERISTICS	72
5.2	VELOCITY DEPENDENT CONTROL	25	20.1	OPERATIONAL RANGE	72
5.3	STALLGUARD CONTROL	26	20.2	DC AND TIMING CHARACTERISTICS	73
5.4	SEQUENCER REGISTERS	28	20.3	THERMAL CHARACTERISTICS	77
5.5	CHOPPER CONTROL REGISTERS	29	21	LAYOUT CONSIDERATIONS	78
6	STEALTHCHOP™	35	21.1	EXPOSED DIE PAD	78
6.1	AUTOMATIC TUNING	35	21.2	WIRING GND	78
6.2	STEALTHCHOP OPTIONS	37	21.3	SUPPLY FILTERING	78
6.3	STEALTHCHOP CURRENT REGULATOR	37	21.4	LAYOUT EXAMPLE TMC2209	79
6.4	VELOCITY BASED SCALING	39	22	PACKAGE MECHANICAL DATA	80
6.5	COMBINE STEALTHCHOP AND SPREADCYCLE	41	22.1	DIMENSIONAL DRAWINGS QFN28	80
6.6	FLAGS IN STEALTHCHOP	42	22.2	PACKAGE CODES	81
6.7	FREEWHEELING AND PASSIVE BRAKING	43	23	TABLE OF FIGURES	82
7	SPREADCYCLE CHOPPER	45	24	REVISION HISTORY	83
7.1	SPREADCYCLE SETTINGS	46	25	REFERENCES	83
8	SELECTING SENSE RESISTORS	49			
9	MOTOR CURRENT CONTROL	50			

1 Principles of Operation

The TMC22xx family of stepper drivers is intended as a drop-in upgrade for existing low-cost stepper driver applications. Their silent drive technology StealthChop enables non-bugging motion control for home and office applications. A highly efficient power stage enables high current from a tiny package. The TMC2209 requires just a few control pins on its tiny package. It allows selection of the most important setting: the desired microstep resolution. A choice of 8, 16, 32 or 64 microsteps, or from fullstep up to 1/256 step adapts the driver to the capabilities of the motion controller.

Even at low microstepping rate, the TMC2209 offers a number of unique enhancements over comparable products: TRINAMICs sophisticated StealthChop2 chopper plus the microstep enhancement MicroPlyer ensure noiseless operation, maximum efficiency and best motor torque. Its fast current regulation and optional combination with SpreadCycle allow for highly dynamic motion. Protection and diagnostic features support robust and reliable operation. A simple-to-use 8 bit UART interface opens up more tuning and control options. Application specific tuning can be stored to on-chip OTP memory. Industries' most advanced step & direction stepper motor driver family upgrades designs to noiseless and most precise operation for cost-effective and highly competitive solutions.

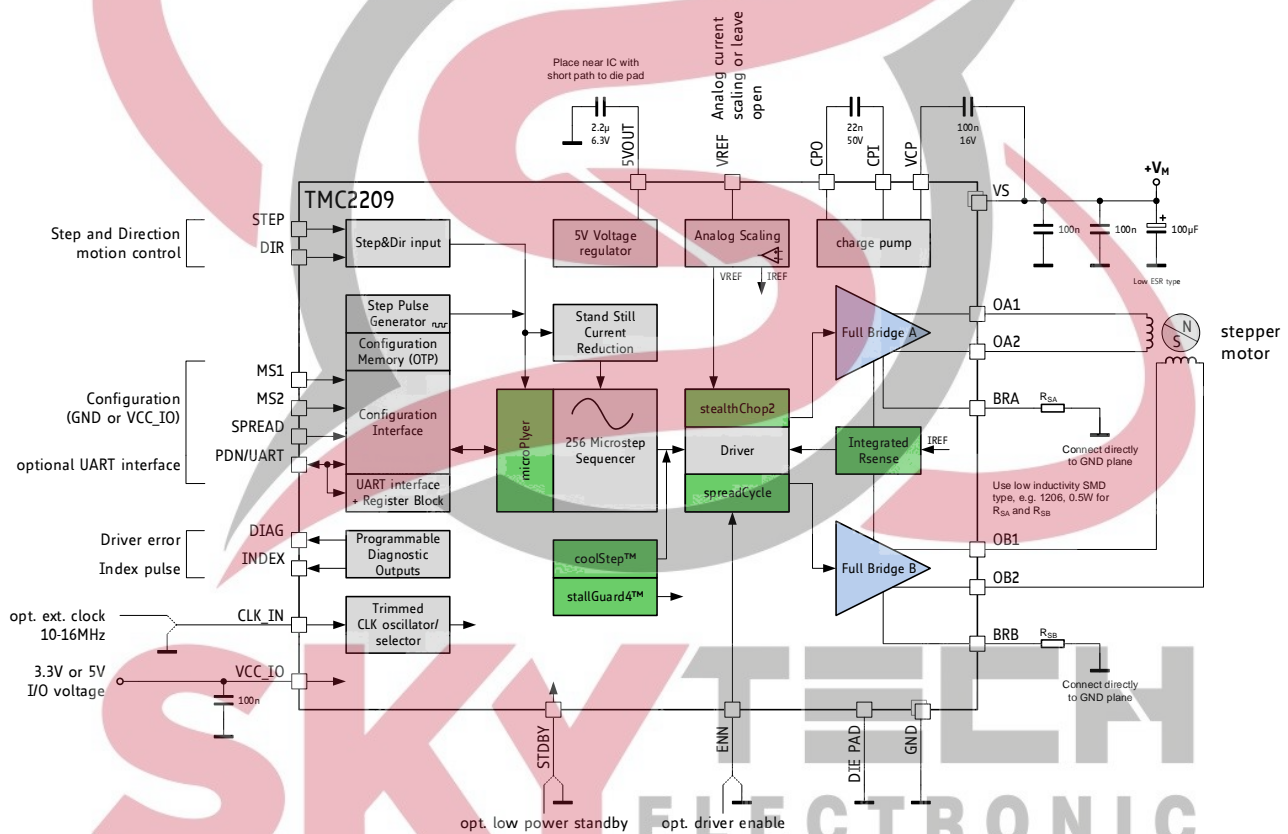

Figure 1.1 TMC2209 basic application block diagram

THREE MODES OF OPERATION:

OPTION 1: Standalone STEP/DIR Driver (Legacy Mode)

A CPU (μ C) generates step & direction signals synchronized to additional motors and other components within the system. The TMC2209 operates the motor as commanded by the configuration pins and STEP/DIR signals. Motor run-current either is fixed, or set by the CPU using the analog input VREF. The pin PDN_UART selects automatic standstill current reduction. Feedback from the driver to

the CPU is granted by the INDEX and DIAG output signals. Enable or disable the motor using the ENN pin.

OPTION 2: Standalone STEP/DIR Driver with OTP pre-configuration

Additional options enabled by pre-programming OTP memory (label UART & OTP):



- + Tuning of the chopper to the application for application tailored performance
- + Cost reduction by switching the driver to internal sense resistor mode
- + Adapting the automatic power down level and timing for best application efficiency

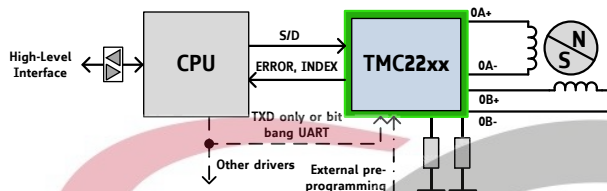

Figure 1.2 Stand-alone driver with pre-configuration

To enable the additional options, either one-time program the driver's OTP memory, or store configuration in the CPU and transfer it to the on-chip registers following each power-up. Operation uses the same signals as Option 1. Programming does not need to be done within the application - it can be executed during testing of the PCB! Alternatively, use bit-banging by CPU firmware to configure the driver. Multiple drivers can be programmed at the same time using a single TXD line.

OPTION 3: STEP/DIR Driver with Full Diagnostics and Control

Similar to Option 2, but pin PDN_UART is connected to the CPU UART interface.



Additional options (label UART):

- + Detailed diagnostics and thermal management
- + Passive braking and freewheeling for flexible, lowest power stop modes
- + More options for microstep resolution setting (fullstep to 256 microstep)
- + Software controlled motor current setting and more chopper options
- + Use StallGuard for sensorless homing and CoolStep for adaptive motor current and cool motor

This mode allows replacing all control lines like ENN, DIAG, INDEX, MS1, MS2, and analog current setting VREF by a single interface line. This way, only three signals are required for full control: STEP, DIR and PDN_UART. Even motion without external STEP pulses is provided by an internal programmable step pulse generator: Just set the desired motor velocity. However, no ramping is provided by the TMC2209.

1.1 Key Concepts

The TMC2209 implements advanced features which are exclusive to TRINAMIC products. These features contribute toward greater precision, greater energy efficiency, higher reliability, smoother motion, and cooler operation in many stepper motor applications.

StealthChop2™ No-noise, high-precision chopper algorithm for inaudible motion and inaudible standstill of the motor. Allows faster motor acceleration and deceleration than StealthChop™ and extends StealthChop to low stand still motor currents.

SpreadCycle™ High-precision cycle-by-cycle current control for highest dynamic movements.

MicroPlyer™ Microstep interpolator for obtaining full 256 microstep smoothness with lower resolution step inputs starting from fullstep

StallGuard4™ Sensorless homing safes end switches and warns in case of motor overload

CoolStep™ Uses StallGuard measurement in order to adapt the motor current for best efficiency and lowest heat-up of motor and driver

In addition to these performance enhancements, TRINAMIC motor drivers offer safeguards to detect and protect against shorted outputs, output open-circuit, overtemperature, and undervoltage conditions for enhancing safety and recovery from equipment malfunctions.

1.2 Control Interfaces

The TMC2209 supports both, discrete control lines for basic mode selection and a UART based single wire interface with CRC checking. The UART interface automatically becomes enabled when correct UART data is sent. When using UART, the pin selection may be disabled by control bits.



1.2.1 UART Interface

The single wire interface allows unidirectional operation (for parameter setting only), or bi-directional operation for full control and diagnostics. It can be driven by any standard microcontroller UART or even by bit banging in software. Baud rates from 9600 Baud to 500k Baud or even higher (when using an external clock) may be used. No baud rate configuration is required, as the TMC2209 automatically adapts to the masters' baud rate. The frame format is identical to the intelligent TRINAMIC controller & driver ICs TMC5130, TMC516x and TMC5072. A CRC checksum allows data transmission over longer distance. For fixed initialization sequences, store the data including CRC into the μ C, thus consuming only a few 100 bytes of code for a full initialization. CRC may be ignored during read access, if not desired. This makes CRC use an optional feature! The IC supports four address settings to access up to four ICs on a single bus. Even more drivers can be programmed in parallel by tying together all interface pins, in case no read access is required. An optional addressing can be provided by analog multiplexers, like 74HC4066.

From a software point of view the TMC2209 is a peripheral with a number of control and status registers. Most of them can either be written only or are read only. Some of the registers allow both, read and write access. In case read-modify-write access is desired for a write only register, realize a shadow register in master software.

1.3 Moving and Controlling the Motor

1.3.1 STEP/DIR Interface

The motor is controlled by a step and direction input. Active edges on the STEP input can be rising edges or both rising and falling edges as controlled by a special mode bit (DEDGE). Using both edges cuts the toggle rate of the STEP signal in half, which is useful for communication over slow interfaces such as optically isolated interfaces. The state sampled from the DIR input upon an active STEP edge determines whether to step forward or back. Each step can be a fullstep or a microstep, in which there are 2, 4, 8, 16, 32, 64, 128, or 256 microsteps per fullstep. A step impulse with a low state on DIR increases the microstep counter and a high decreases the counter by an amount controlled by the microstep resolution. An internal table translates the counter value into the sine and cosine values which control the motor current for microstepping.

1.3.2 Internal Step Pulse Generator

Some applications do not require a precisely co-ordinate motion – the motor just is required to move for a certain time and at a certain velocity. The TMC2209 comes with an internal pulse generator for these applications: Just provide the velocity via UART interface to move the motor. The velocity sign automatically controls the direction of the motion. However, the pulse generator does not integrate a ramping function. Motion at higher velocities will require ramping up and ramping down the velocity value via software.

STEP/DIR mode and internal pulse generator mode can be mixed in an application!



1.4 StealthChop2 & SpreadCycle Driver

StealthChop is a voltage-chopper based principle. It especially guarantees that the motor is absolutely quiet in standstill and in slow motion, except for noise generated by ball bearings. Unlike other voltage mode choppers, StealthChop2 does not require any configuration. It automatically learns the

1.7 Automatic Standstill Power Down

An automatic current reduction drastically reduces application power dissipation and cooling requirements. Per default, the stand still current reduction is enabled by pulling PDN_UART input to GND. It reduces standstill power dissipation to less than 33% by going to slightly more than half of the run current.

Modify stand still current, delay time and decay via UART, or pre-programmed via internal OTP. Automatic freewheeling and passive motor braking are provided as an option for stand still. Passive braking reduces motor standstill power consumption to zero, while still providing effective dampening and braking!

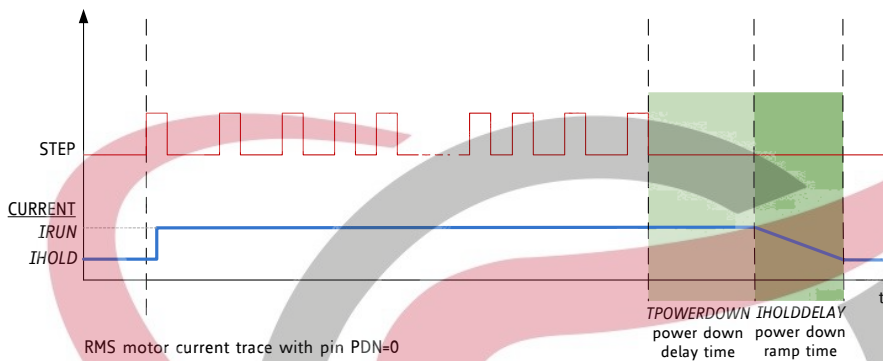

Figure 1.4 Automatic Motor Current Power Down

1.8 Index Output

The index output gives one pulse per electrical rotation, i.e. one pulse per each four fullsteps. It shows the internal sequencer microstep 0 position (*MSTEP* near 0). This is the power on position. In combination with a mechanical home switch, a more precise homing is enabled.

1.9 Precise clock generator and CLK input

The TMC2209 provides a factory trimmed internal clock generator for precise chopper frequency and performance. However, an optional external clock input is available for cases, where quartz precision is desired, or where a lower or higher frequency is required. For safety, the clock input features timeout detection, and switches back to internal clock upon fail of the external source.

SKYTECH
ELECTRONIC

2 Pin Assignments

The TMC2209 comes in a compact QFN package.

2.1 Package Outline TMC2209

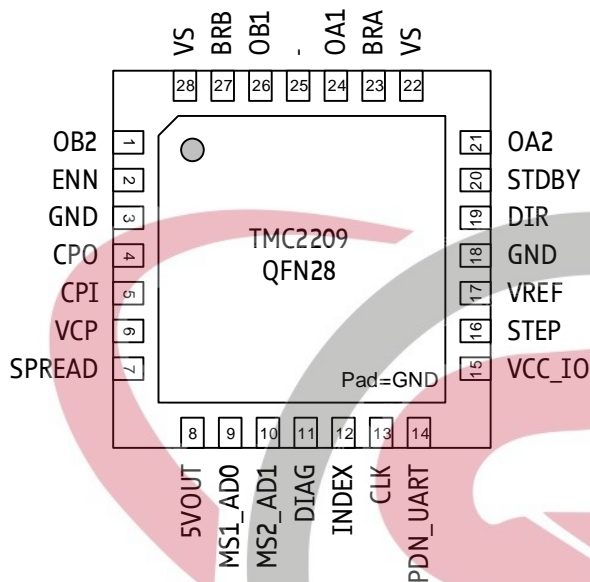

Figure 2.1 TMC2209 Pinning Top View – type: QFN28, 5x5mm², 0.5mm pitch

2.2 Signal Descriptions TMC2209

Pin	Number	Type	Function
OB2	1		Motor coil B output 2
ENN	2	DI	Enable not input. The power stage becomes switched off (all motor outputs floating) when this pin becomes driven to a high level.
GND	3, 18		GND. Connect to GND plane near pin.
CPO	4		Charge pump capacitor output.
CPI	5		Charge pump capacitor input. Tie to CPO using 22nF 50V capacitor.
VCP	6		Charge pump voltage. Tie to VS using 100nF capacitor.
SPREAD	7	DI (pd)	Chopper mode selection: Low=StealthChop, High=SpreadCycle (may be left unconnected)
5VOUT	8		Output of internal 5V regulator. Attach 2.2µF to 4.7µF ceramic capacitor to GND near to pin for best performance. Provide the shortest possible loop to the GND pad.
MS1_ADO	9	DI (pd)	Microstep resolution configuration (internal pull-down resistors) MS2, MS1: 00: 1/8, 01: 1/32, 10: 1/64 11: 1/16 For UART based configuration selection of UART Address 0..3
MS2_AD1	10	DI (pd)	
DIAG	11	DO	Diagnostic and StallGuard output. Hi level upon stall detection or driver error. Reset error condition by ENN=high.
INDEX	12	DO	Configurable index output. Provides index pulse.
CLK	13	DI	CLK input. Tie to GND using short wire for internal clock or supply external clock.
PDN_UART	14	DIO	Power down not control input (low = automatic standstill current reduction). Optional UART Input/Output. Power down function can be disabled in UART mode.

Pin	Number	Type	Function
VCC_IO	15		3.3V to 5V IO supply voltage for all digital pins.
STEP	16	DI	STEP input
VREF	17	AI	Analog reference voltage for current scaling or reference current for use of internal sense resistors (optional mode)
DIR	19	DI (pd)	DIR input (internal pull-down resistor)
STDBY	20	DI (pd)	STANDBY input. Pull up to disable driver internal supply regulator. This will bring the driver into a low power dissipation state. 100kOhm pulldown. (may be left unconnected) <i>Hint: Also shut down VREF voltage and ENN to 0V during standby.</i>
VS	22, 28		Motor supply voltage. Provide filtering capacity near pin with shortest possible loop to GND pad.
OA2	21		Motor coil A output 2
BRA	23		Sense resistor connection for coil A. Place sense resistor to GND near pin. Tie to GND when using internal sense resistor.
OA1	24		Motor coil A output 1
-	25	unused	May be connected to GND for better PCB routing
OB1	26		Motor coil B output 1
BRB	27		Sense resistor connection for coil B. Place sense resistor to GND near pin. Tie to GND when using internal sense resistor.
Exposed die pad	-		Connect the exposed die pad to a GND plane. Provide as many as possible vias for heat transfer to GND plane. Serves as GND pin for power drivers and analogue circuitry.



SKYTECH
ELECTRONIC

3 Sample Circuits

The sample circuits show the connection of external components in different operation and supply modes. The connection of the bus interface and further digital signals is left out for clarity.

3.1 Standard Application Circuit

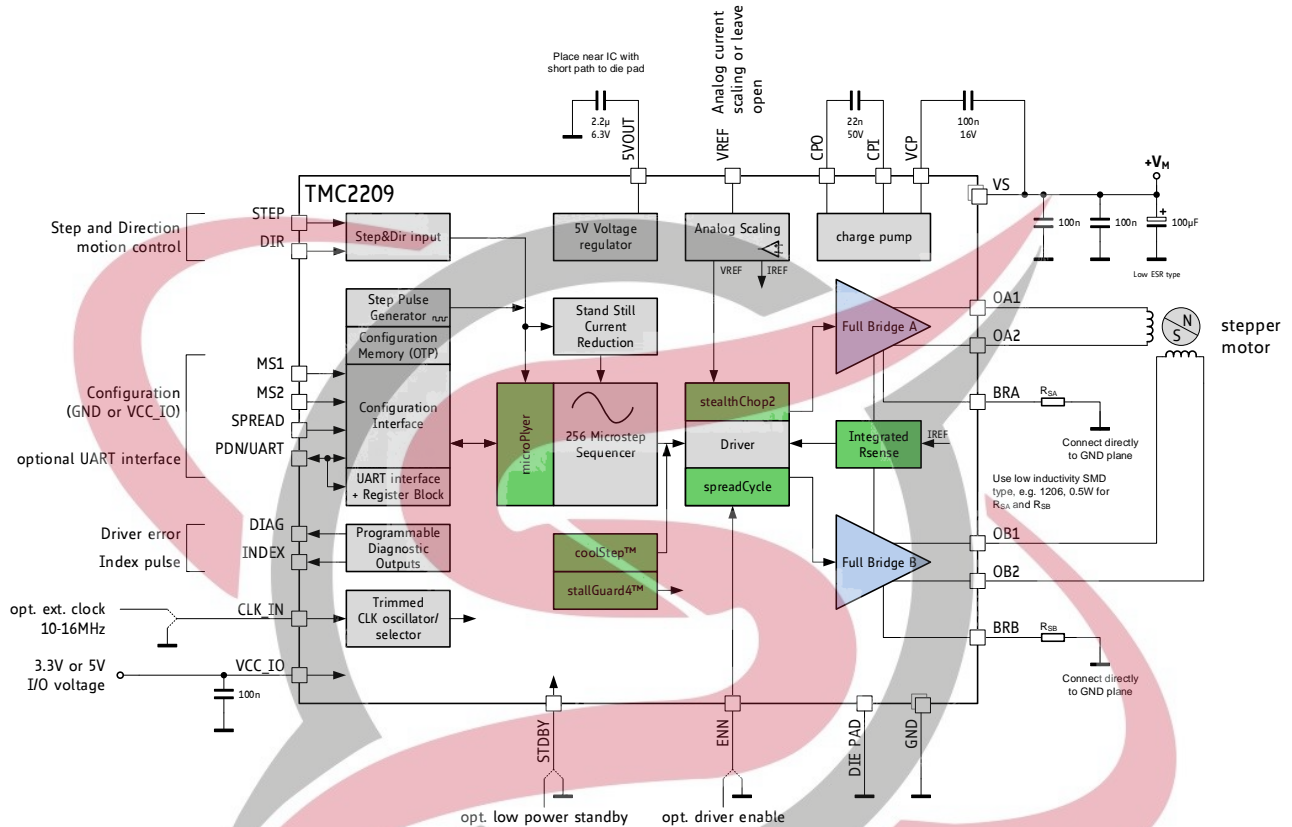

Figure 3.1 Standard application circuit

The standard application circuit uses a minimum set of additional components. Two sense resistors set the motor coil current. See chapter 8 to choose the right sense resistors. Use low ESR capacitors for filtering the power supply. The capacitors need to cope with the current ripple cause by chopper operation. A minimum capacity of 100µF near the driver is recommended for best performance. Current ripple in the supply capacitors also depends on the power supply internal resistance and cable length. VCC_IO can be supplied from 5VOUT, or from an external source, e.g. a 3.3V regulator.

Basic layout hints

Place sense resistors and all filter capacitors as close as possible to the related IC pins. Use a solid common GND for all GND connections, also for sense resistor GND. Connect 5VOUT filtering capacitor directly to 5VOUT and the die pad. See layout hints for more details. Low ESR electrolytic capacitors are recommended for VS filtering.

3.2 Internal RDSon Sensing

For cost critical or space limited applications, sense resistors can be omitted. For internal current sensing, a reference current set by a tiny external resistor programs the output current. For calculation of the reference resistor, refer chapter 9.1.

Attention

Be sure to switch the IC to RDSon mode, before enabling drivers: Set `otp_internalRsense = 1`.

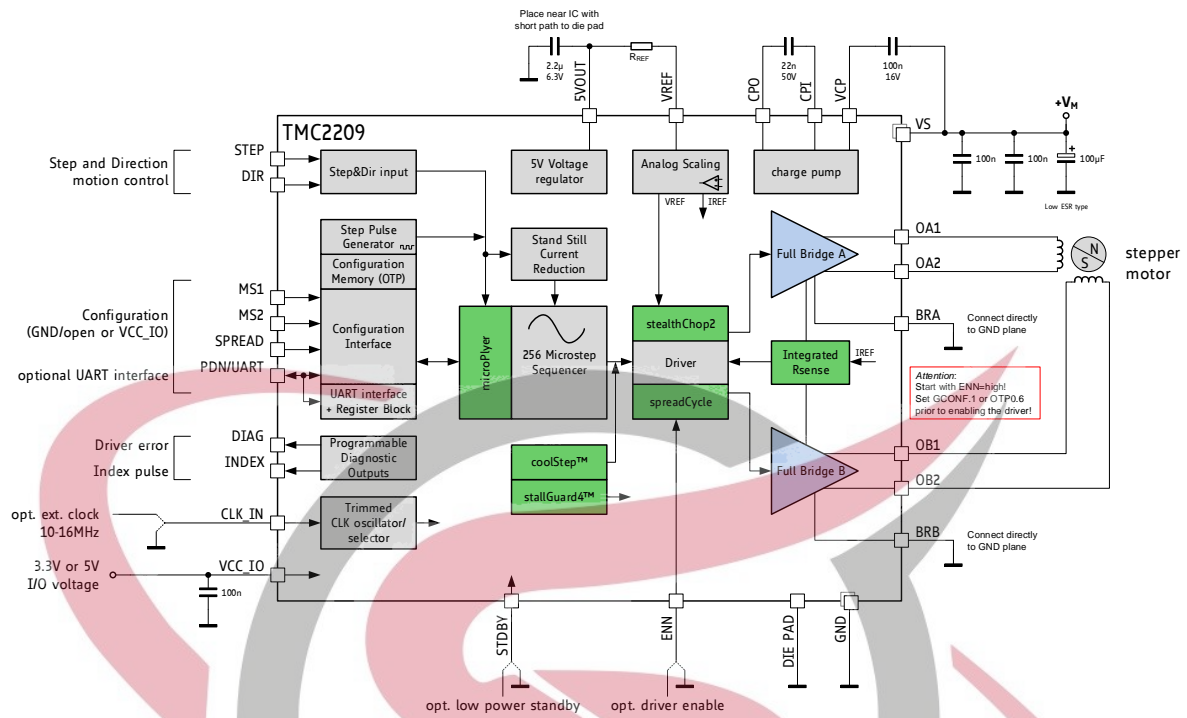

Figure 3.2 Application circuit using RDSon based sensing

3.3 5V Only Supply

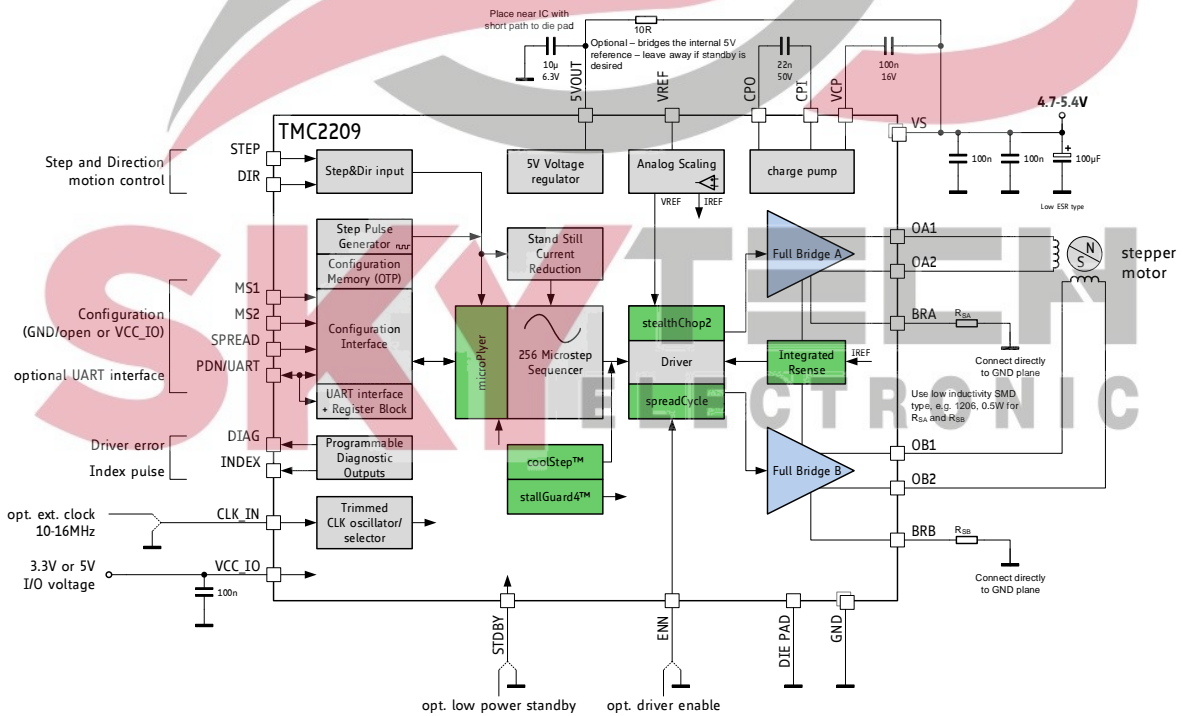

Figure 3.3 5V only operation

While the standard application circuit is limited to roughly 5.2 V lower supply voltage, a 5 V only application lets the IC run from a 5 V +/-5% supply. In this application, linear regulator drop must be minimized. Therefore, the internal 5V regulator is filtered with a higher capacitance. An optional resistor bridges the internal 5V regulator by connecting 5VOUT to the external power supply. This RC filter keeps chopper ripple away from 5VOUT. With this resistor, the external supply is the reference for the absolute motor current and must not exceed 5.5V. Standby function will not work in this application, because the 5V regulator is bridged.

3.4 Configuration Pins

The TMC2209 provides four configuration pins. These pins allow quick configuration for standalone operation. Several additional options can be set by OTP programming. In UART mode, the configuration pins can be disabled in order to set a different configuration via registers.

PDN_UART: CONFIGURATION OF STANDSTILL POWER DOWN	
PDN_UART	Current Setting
GND	Enable automatic power down in standstill periods
VCC_IO	Disable
UART interface	When using the UART interface, the configuration pin should be disabled via <i>GCONF.pdn_disable</i> = 1. Program <i>IHOLD</i> as desired for standstill periods.

MS1/MS2: CONFIGURATION OF MICROSTEP RESOLUTION FOR STEP INPUT		
MS2	MS1	Microstep Setting
GND	GND	8 microsteps
GND	VCC_IO	32 microsteps (different to TMC2208!)
VCC_IO	GND	64 microsteps (different to TMC2208!)
VCC_IO	VCC_IO	16 microsteps

SPREAD: SELECTION OF CHOPPER MODE	
SPREAD	Chopper Setting
GND or Pin open / not available	StealthChop is selected. Automatic switching to SpreadCycle in dependence of the step frequency can be programmed via OTP.
VCC_IO	SpreadCycle operation.

3.5 High Motor Current

When operating at a high motor current, the driver power dissipation due to MOSFET switch on-resistance significantly heats up the driver. This power dissipation will significantly heat up the PCB cooling infrastructure, if operated at an increased duty cycle. This in turn leads to a further increase of driver temperature. An increase of temperature by about 100°C increases MOSFET resistance by roughly 50%. This is a typical behavior of MOSFET switches. Therefore, under high duty cycle, high load conditions, thermal characteristics have to be carefully taken into account, especially when increased environment temperatures are to be supported. Refer the thermal characteristics and the layout hints for more information. As a thumb rule, thermal properties of the PCB design become critical for the tiny QFN 5mm x 5mm package at or above 1.4A RMS motor current for increased periods of time. Keep in mind that resistive power dissipation rises with the square of the motor current. On the other hand, this means that a small reduction of motor current significantly saves heat dissipation and energy.

Pay special attention to good thermal properties of your PCB layout, when going for 1.4A RMS current or more.

An effect which might be perceived at medium motor velocities and motor sine wave peak currents above roughly 2A peak is a slight sine distortion of the current wave when using SpreadCycle. It results from an increasing negative impact of parasitic internal diode conduction, which in turn negatively influences the duration of the fast decay cycle of the SpreadCycle chopper. This is, because the current measurement does not see the full coil current during this phase of the sine wave, because an increasing part of the current flows directly from the power MOSFETs' drain to GND and does not flow through the sense resistor. This effect with most motors does not negatively influence the smoothness of operation, as it does not impact the critical current zero transition. The effect does not occur with StealthChop.

3.6 Low Power Standby

Battery powered applications, and mains powered applications conforming to standby energy saving rules, often require a standby operation, where the power-supply remains on, but current draw goes down to a low value. The TMC2209 supports standby operation of roughly 2mW (at 12V supply), or <1mW at 5V supply using a dedicated pin STANDBY. Pull up STANDBY to VCC_IO to go to low power standby. VCC_IO may be dropped down to 1.5V during standby. A high level on STANDBY will disable the internal 5V regulator and at the same time switches off all internal units. Prior to going to STANDBY, stop the motor, and allow it to enter standstill current, or switch off the motor completely. When in STANDBY, inputs ENN and VREF have to be driven to a low level. VCC_IO shall remain active in standby mode. All driver registers are reset to their power-up defaults after leaving standby mode.

3.7 Driver Protection and EME Circuitry

Some applications have to cope with ESD events caused by motor operation or external influence. Despite ESD circuitry within the driver chips, ESD events occurring during operation can cause a reset or even a destruction of the motor driver, depending on their energy. Especially plastic housings and belt drive systems tend to cause ESD events of several kV. It is best practice to avoid ESD events by attaching all conductive parts, especially the motors themselves to PCB ground, or to apply electrically conductive plastic parts. In addition, the driver can be protected up to a certain degree against ESD events or live plugging / pulling the motor, which also causes high voltages and high currents into the motor connector terminals. A simple scheme uses capacitors at the driver outputs to reduce the dV/dt caused by ESD events. Larger capacitors will bring more benefit concerning ESD suppression, but cause additional current flow in each chopper cycle, and thus increase driver power dissipation, especially at high supply voltages. The values shown are example values – they may be varied between 100pF and 1nF. The capacitors also dampen high frequency noise injected from digital parts of the application PCB circuitry and thus reduce electromagnetic emission. A more elaborate scheme uses LC filters to de-couple the driver outputs from the motor connector. Varistors in between of the coil terminals eliminate coil overvoltage caused by live plugging. Optionally protect all outputs by a varistor to GND against ESD voltage.

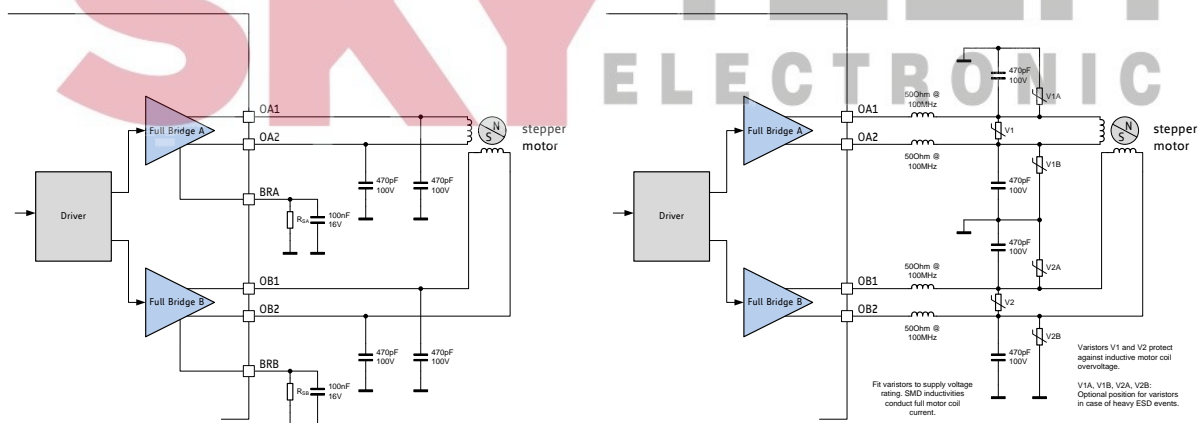

Figure 3.4 Simple ESD enhancement and more elaborate motor output protection



4 UART Single Wire Interface

The UART single wire interface allows control of the TMC2209 with any microcontroller UART. It shares transmit and receive line like an RS485 based interface. Data transmission is secured using a cyclic redundancy check, so that increased interface distances (e.g. over cables between two PCBs) can be bridged without danger of wrong or missed commands even in the event of electro-magnetic disturbance. The automatic baud rate detection makes this interface easy to use.

4.1 Datagram Structure

4.1.1 Write Access

UART WRITE ACCESS DATAGRAM STRUCTURE																			
each byte is LSB...MSB, highest byte transmitted first																			
0 ... 63																			
sync + reserved				8 bit slave address				RW + 7 bit register addr.			32 bit data				CRC				
0...7				8...15				16...23			24...55				56...63				
1	0	1	0	Reserved (don't cares but included in CRC)				register address			data bytes 3, 2, 1, 0 (high to low byte)				CRC				
0	1	2	3	4	5	6	7	8	:	15	16	:	23	24	:	55	56	:	63

A sync nibble precedes each transmission to and from the TMC2209 and is embedded into the first transmitted byte, followed by an addressing byte (0 to 3 for TMC2209, depending on address setting). Each transmission allows a synchronization of the internal baud rate divider to the master clock. The actual baud rate is adapted and variations of the internal clock frequency are compensated. Thus, the baud rate can be freely chosen within the valid range. Each transmitted byte starts with a start bit (logic 0, low level on SWIOP) and ends with a stop bit (logic 1, high level on SWIOP). The bit time is calculated by measuring the time from the beginning of start bit (1 to 0 transition) to the end of the sync frame (1 to 0 transition from bit 2 to bit 3). All data is transmitted byte-wise. The 32 bit data words are transmitted with the highest byte first.

A minimum baud rate of 9000 baud is permissible, assuming 20 MHz clock (worst case for low baud rate). Maximum baud rate is $f_{CLK}/16$ due to the required stability of the baud clock.

The slave address *SLAVEADDR* is selected by MS1 (bit 0) and MS2 (bit 1).

The communication becomes reset if a pause time of longer than 63 bit times between the start bits of two successive bytes occurs. This timing is based on the last correctly received datagram. In this case, the transmission needs to be restarted after a failure recovery time of minimum 12 bit times of bus idle time. This scheme allows the master to reset communication in case of transmission errors. Any pulse on an idle data line below 16 clock cycles will be treated as a glitch and leads to a timeout of 12 bit times, for which the data line must be idle. Other errors like wrong CRC are also treated the same way. This allows a safe re-synchronization of the transmission after any error conditions. Remark, that due to this mechanism an abrupt reduction of the baud rate to less than 15 percent of the previous value is not possible.

Each accepted write datagram becomes acknowledged by the receiver by incrementing an internal cyclic datagram counter (8 bit). Reading out the datagram counter allows the master to check the success of an initialization sequence or single write accesses. Read accesses do not modify the counter.

The UART line must be logic high during idle state. Therefore, the power down function cannot be assigned by the pin PDN_UART in between of transmissions. In an application using the UART interface, set the desired power down function by register access and set *pdn_disable* in GCONF to disable the pin function.

4.1.2 Read Access

UART READ ACCESS REQUEST DATAGRAM STRUCTURE																
each byte is LSB...MSB, highest byte transmitted first																
sync + reserved				8 bit slave address				RW + 7 bit register address				CRC				
0...7				8...15				16...23				24...31				
1	0	1	0	Reserved (don't cares but included in CRC)				SLAVEADDR=0...3				0	CRC			
0	1	2	3	4	5	6	7	8	...	15	16	...	23	24	...	31

The read access request datagram structure is identical to the write access datagram structure, but uses a lower number of user bits. Its function is the addressing of the slave and the transmission of the desired register address for the read access. The TMC2209 responds with the same baud rate as the master uses for the read request.

In order to ensure a clean bus transition from the master to the slave, the TMC2209 does not immediately send the reply to a read access, but it uses a programmable delay time after which the first reply byte becomes sent following a read request. This delay time can be set in multiples of eight bit times using *SENDDelay* time setting (default=8 bit times) according to the needs of the master.

UART READ ACCESS REPLY DATAGRAM STRUCTURE																			
each byte is LSB...MSB, highest byte transmitted first																			
0 63																			
sync + reserved				8 bit master address				RW + 7 bit register addr.		32 bit data				CRC					
0...7				8...15				16...23		24...55				56...63					
1	0	1	0	reserved (0)				0xFF		register address		0		data bytes 3, 2, 1, 0 (high to low byte)		CRC			
0	1	2	3	4	5	6	7	8	...	15	16	...	23	24	...	55	56	...	63

The read response is sent to the master using address code %11111111. The transmitter becomes switched inactive four bit times after the last bit is sent.

Address %11111111 is reserved for read access replies going to the master.

4.2 CRC Calculation

An 8 bit CRC polynomial is used for checking both read and write access. It allows detection of up to eight single bit errors. The CRC8-ATM polynomial with an initial value of zero is applied LSB to MSB, including the sync- and addressing byte. The sync nibble is assumed to always be correct. The TMC2209 responds only to correctly transmitted datagrams containing its own slave address. It increases its datagram counter for each correctly received write access datagram.

$$CRC = x^8 + x^2 + x^1 + x^0$$

SERIAL CALCULATION EXAMPLE

`CRC = (CRC << 1) OR (CRC.7 XOR CRC.1 XOR CRC.0 XOR [new incoming bit])`

C-CODE EXAMPLE FOR CRC CALCULATION

```
void swuart_calcCRC(UCHAR* datagram, UCHAR datagramLength)
{
    int i,j;
    UCHAR* crc = datagram + (datagramLength-1); // CRC located in last byte of message
    UCHAR currentByte;

    *crc = 0;
    for (i=0; i<(datagramLength-1); i++) { // Execute for all bytes of a message
        currentByte = datagram[i]; // Retrieve a byte to be sent from Array
        for (j=0; j<8; j++) {
            if ((*crc >> 7) ^ (currentByte&0x01)) // update CRC based result of XOR operation
            {
                *crc = (*crc << 1) ^ 0x07;
            }
            else
            {
                *crc = (*crc << 1);
            }
            currentByte = currentByte >> 1;
        } // for CRC bit
    } // for message byte
}
```

4.3 UART Signals

The UART interface on the TMC2209 uses a single bi-direction pin:

UART INTERFACE SIGNAL	
PDN_UART	Non-inverted data input and output. I/O with Schmitt Trigger and VCC_IO level.
MS1_ADDR0	IC UART address bit 0 (LSB)
MS2_ADDR1	IC UART address bit 1

The IC checks PDN_UART for correctly received datagrams with its own address continuously. It adapts to the baud rate based on the sync nibble, as described before. In case of a read access, it switches on its output drivers and sends its response using the same baud rate. The output becomes switched off four bit times after transfer of the last stop bit.

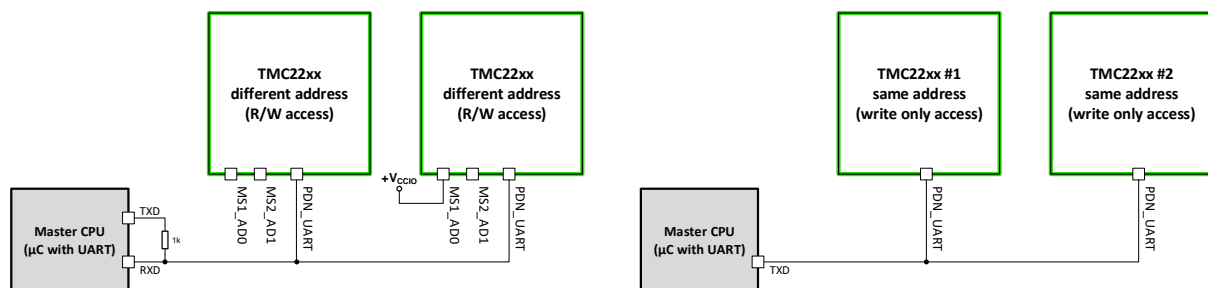

Figure 4.1 Attaching the TMC2209 to a microcontroller UART

4.4 Addressing Multiple Slaves

WRITE ONLY ACCESS

If read access is not used, and all slaves are to be programmed with the same initialization values, no addressing is required. All slaves can be programmed in parallel like a single device (Figure 4.1.).

ADDRESSING MULTIPLE SLAVES

As the TMC2209 uses has a limited number of UART addresses, in principle only up to four ICs can be accessed per UART interface channel. Adding analog switches allows separated access to more individual ICs. This scheme is similar to an SPI bus with individual slave select lines (Figure 4.2). With this scheme, the microstep resolution can be selected via MS1 and MS2 pins (consider actual setting for addressing).

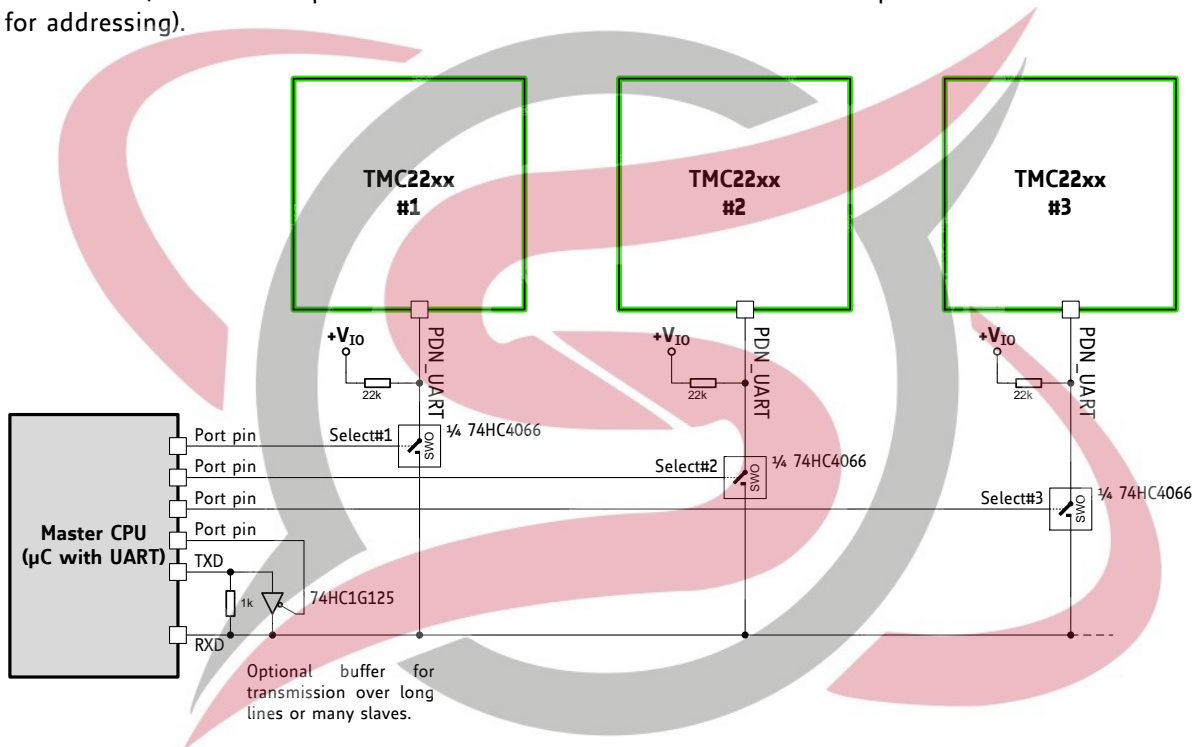

Figure 4.2 Addressing multiple TMC2209 via single wire interface using analog switches

PROCEED AS FOLLOWS TO CONTROL MULTIPLE SLAVES:

- Set the UART to 8 bits, no parity. Select a baud rate safely within the valid range. At 250kBaund, a write access transmission requires $320\mu\text{s}$ ($=8 \text{ Bytes} * (8+2) \text{ bits} * 4\mu\text{s}$).
- Before starting an access, activate the select pin going to the analog switch by setting it high. All other slaves select lines shall be off, unless a broadcast is desired.
- When using the optional buffer, set TMC2209 transmission send delay to an appropriate value allowing the μC to switch off the buffer before receiving reply data.
- To start a transmission, activate the TXD line buffer by setting the control pin low.
- When sending a read access request, switch off the buffer after transmission of the last stop bit is finished.
- Take into account, that all transmitted data also is received by the RXD input.

5 Register Map



This chapter gives an overview of the complete register set. Some of the registers bundling a number of single bits are detailed in extra tables. The functional practical application of the settings is detailed in dedicated chapters.

Note

- *Reset default:* All registers become reset to 0 upon power up, unless otherwise noted.
- Add 0x80 to the address **Addr** for write accesses!

NOTATION OF HEXADECIMAL AND BINARY NUMBERS

0x	precedes a hexadecimal number, e.g. 0x04
%	precedes a multi-bit binary number, e.g. %100

NOTATION OF R/W FIELD

R	Read only
W	Write only
R/W	Read- and writable register

OVERVIEW REGISTER MAPPING

REGISTER	DESCRIPTION
General Configuration Registers	These registers contain <ul style="list-style-type: none"> - global configuration - global status flags - OTP read access and programming - interface configuration
Velocity Dependent Driver Feature Control Register Set	This register set offers registers for <ul style="list-style-type: none"> - driver current control, stand still reduction - setting thresholds for different chopper modes - internal pulse generator control
Chopper Register Set	This register set offers registers for <ul style="list-style-type: none"> - optimization of StealthChop2 and SpreadCycle and read out of internal values - passive braking and freewheeling options - driver diagnostics - driver enable / disable
CoolStep and StallGuard Control Registers	These registers allow for <ul style="list-style-type: none"> - Sensorless stall detection for homing - Adaptive motor current control for best efficiency

5.1 General Registers

GENERAL CONFIGURATION REGISTERS (0x00...0x0F)																										
R/W	Addr	n	Register	Description / bit names																						
RW	0x00	10	GCONF	<table border="1"> <thead> <tr> <th>Bit</th> <th>GCONF – Global configuration flags</th> </tr> </thead> <tbody> <tr> <td>0</td> <td> <i>I_scale_analog</i> (Reset default=1) 0: Use internal reference derived from 5VOUT 1: Use voltage supplied to VREF as current reference </td> </tr> <tr> <td>1</td> <td> <i>internal_Rsense</i> (Reset default: OTP) 0: Operation with external sense resistors 1: Internal sense resistors. Use current supplied into VREF as reference for internal sense resistor. VREF pin internally is driven to GND in this mode. </td> </tr> <tr> <td>2</td> <td> <i>en_SpreadCycle</i> (Reset default: OTP) 0: StealthChop PWM mode enabled (depending on velocity thresholds). Initially switch from off to on state while in stand still, only. 1: SpreadCycle mode enabled A high level on the pin SPREAD inverts this flag to switch between both chopper modes. </td> </tr> <tr> <td>3</td> <td> <i>shaft</i> 1: Inverse motor direction </td> </tr> <tr> <td>4</td> <td> <i>index_otpw</i> 0: INDEX shows the first microstep position of sequencer 1: INDEX pin outputs overtemperature prewarning flag (<i>otpw</i>) instead </td> </tr> <tr> <td>5</td> <td> <i>index_step</i> 0: INDEX output as selected by <i>index_otpw</i> 1: INDEX output shows step pulses from internal pulse generator (toggle upon each step) </td> </tr> <tr> <td>6</td> <td> <i>pdn_disable</i> 0: PDN_UART controls standstill current reduction 1: PDN_UART input function disabled. Set this bit, when using the UART interface! </td> </tr> <tr> <td>7</td> <td> <i>mstep_reg_select</i> 0: Microstep resolution selected by pins MS1, MS2 1: Microstep resolution selected by MSTEP register </td> </tr> <tr> <td>8</td> <td> <i>multistep_filt</i> (Reset default=1) 0: No filtering of STEP pulses 1: Software pulse generator optimization enabled when fullstep frequency > 750Hz (roughly). TSTEP shows filtered step time values when active. </td> </tr> <tr> <td>9</td> <td> <i>test_mode</i> 0: Normal operation 1: Enable analog test output on pin ENN (pull down resistor off), ENN treated as enabled. <i>IHOLD</i>[1..0] selects the function of DCO: 0..2: T120, DAC, VDDH Attention: Not for user, set to 0 for normal operation! </td> </tr> </tbody> </table>	Bit	GCONF – Global configuration flags	0	<i>I_scale_analog</i> (Reset default=1) 0: Use internal reference derived from 5VOUT 1: Use voltage supplied to VREF as current reference	1	<i>internal_Rsense</i> (Reset default: OTP) 0: Operation with external sense resistors 1: Internal sense resistors. Use current supplied into VREF as reference for internal sense resistor. VREF pin internally is driven to GND in this mode.	2	<i>en_SpreadCycle</i> (Reset default: OTP) 0: StealthChop PWM mode enabled (depending on velocity thresholds). Initially switch from off to on state while in stand still, only. 1: SpreadCycle mode enabled A high level on the pin SPREAD inverts this flag to switch between both chopper modes.	3	<i>shaft</i> 1: Inverse motor direction	4	<i>index_otpw</i> 0: INDEX shows the first microstep position of sequencer 1: INDEX pin outputs overtemperature prewarning flag (<i>otpw</i>) instead	5	<i>index_step</i> 0: INDEX output as selected by <i>index_otpw</i> 1: INDEX output shows step pulses from internal pulse generator (toggle upon each step)	6	<i>pdn_disable</i> 0: PDN_UART controls standstill current reduction 1: PDN_UART input function disabled. Set this bit, when using the UART interface!	7	<i>mstep_reg_select</i> 0: Microstep resolution selected by pins MS1, MS2 1: Microstep resolution selected by MSTEP register	8	<i>multistep_filt</i> (Reset default=1) 0: No filtering of STEP pulses 1: Software pulse generator optimization enabled when fullstep frequency > 750Hz (roughly). TSTEP shows filtered step time values when active.	9	<i>test_mode</i> 0: Normal operation 1: Enable analog test output on pin ENN (pull down resistor off), ENN treated as enabled. <i>IHOLD</i> [1..0] selects the function of DCO: 0..2: T120, DAC, VDDH Attention: Not for user, set to 0 for normal operation!
				Bit	GCONF – Global configuration flags																					
				0	<i>I_scale_analog</i> (Reset default=1) 0: Use internal reference derived from 5VOUT 1: Use voltage supplied to VREF as current reference																					
				1	<i>internal_Rsense</i> (Reset default: OTP) 0: Operation with external sense resistors 1: Internal sense resistors. Use current supplied into VREF as reference for internal sense resistor. VREF pin internally is driven to GND in this mode.																					
				2	<i>en_SpreadCycle</i> (Reset default: OTP) 0: StealthChop PWM mode enabled (depending on velocity thresholds). Initially switch from off to on state while in stand still, only. 1: SpreadCycle mode enabled A high level on the pin SPREAD inverts this flag to switch between both chopper modes.																					
				3	<i>shaft</i> 1: Inverse motor direction																					
				4	<i>index_otpw</i> 0: INDEX shows the first microstep position of sequencer 1: INDEX pin outputs overtemperature prewarning flag (<i>otpw</i>) instead																					
				5	<i>index_step</i> 0: INDEX output as selected by <i>index_otpw</i> 1: INDEX output shows step pulses from internal pulse generator (toggle upon each step)																					
				6	<i>pdn_disable</i> 0: PDN_UART controls standstill current reduction 1: PDN_UART input function disabled. Set this bit, when using the UART interface!																					
				7	<i>mstep_reg_select</i> 0: Microstep resolution selected by pins MS1, MS2 1: Microstep resolution selected by MSTEP register																					
8	<i>multistep_filt</i> (Reset default=1) 0: No filtering of STEP pulses 1: Software pulse generator optimization enabled when fullstep frequency > 750Hz (roughly). TSTEP shows filtered step time values when active.																									
9	<i>test_mode</i> 0: Normal operation 1: Enable analog test output on pin ENN (pull down resistor off), ENN treated as enabled. <i>IHOLD</i> [1..0] selects the function of DCO: 0..2: T120, DAC, VDDH Attention: Not for user, set to 0 for normal operation!																									

GENERAL CONFIGURATION REGISTERS (0x00...0x0F)				
R/W	Addr	n	Register	Description / bit names
R+ WC	0x01	3	GSTAT	Bit GSTAT – Global status flags (Re-Write with '1' bit to clear respective flags)
				0 <i>reset</i> 1: Indicates that the IC has been reset since the last read access to GSTAT. All registers have been cleared to reset values.
				1 <i>drv_err</i> 1: Indicates, that the driver has been shut down due to overtemperature or short circuit detection since the last read access. Read DRV_STATUS for details. The flag can only be cleared when all error conditions are cleared.
				2 <i>uv_cp</i> 1: Indicates an undervoltage on the charge pump. The driver is disabled in this case. This flag is not latched and thus does not need to be cleared.
R	0x02	8	IFCNT	Interface transmission counter. This register becomes incremented with each successful UART interface write access. Read out to check the serial transmission for lost data. Read accesses do not change the content. The counter wraps around from 255 to 0.
W	0x03	4	SLAVECONF	Bit SLAVECONF 11..8 SENDDELAY for read access (time until reply is sent): 0, 1: 8 bit times 2, 3: 3*8 bit times 4, 5: 5*8 bit times 6, 7: 7*8 bit times 8, 9: 9*8 bit times 10, 11: 11*8 bit times 12, 13: 13*8 bit times 14, 15: 15*8 bit times
W	0x04	16	OTP_PROG	Bit OTP_PROGRAM – OTP programming Write access programs OTP memory (one bit at a time), Read access refreshes read data from OTP after a write 2..0 <i>OTPBIT</i> Selection of OTP bit to be programmed to the selected byte location (n=0..7: programs bit n to a logic 1) 5..4 <i>OTPBYTE</i> Selection of OTP programming location (0, 1 or 2) 15..8 <i>OTPMAGIC</i> Set to 0xbd to enable programming. A programming time of minimum 10ms per bit is recommended (check by reading <i>OTP_READ</i>).
R	0x05	24	OTP_READ	Bit OTP_READ (Access to OTP memory result and update) <i>See separate table!</i> 7..0 <i>OTP0</i> byte 0 read data 15..8 <i>OTP1</i> byte 1 read data 23..16 <i>OTP2</i> byte 2 read data
R	0x06	10 + 8	IOIN	Bit INPUT (Reads the state of all input pins available) 0 ENN 1 0 2 MS1 3 MS2

GENERAL CONFIGURATION REGISTERS (0x00...0x0F)				
R/W	Addr	n	Register	Description / bit names
				4 DIAG
				5 0
				6 PDN_UART
				7 STEP
				8 SPREAD_EN
				9 DIR
				31.. 24 <i>VERSION</i> : 0x21=first version of the IC Identical numbers mean full digital compatibility.
RW	0x07	5+2	<i>FACTORY_CONF</i>	4..0 <i>FCLKTRIM</i> (Reset default: OTP) 0..31: Lowest to highest clock frequency. Check at charge pump output. The frequency span is not guaranteed, but it is tested, that tuning to 12MHz internal clock is possible. The devices come preset to 12MHz clock frequency by OTP programming.
				9..8 <i>OTTRIM</i> (Default: OTP) %00: OT=143°C, OTPW=120°C %01: OT=150°C, OTPW=120°C %10: OT=150°C, OTPW=143°C %11: OT=157°C, OTPW=143°C



SKYTECH
ELECTRONIC

5.1.1 OTP_READ – OTP configuration memory

The OTP memory holds power up defaults for certain registers. All OTP memory bits are cleared to 0 by default. Programming only can set bits, clearing bits is not possible. Factory tuning of the clock frequency affects *otp0.0* to *otp0.4*. The state of these bits therefore may differ between individual ICs.

0x05: OTP_READ – OTP MEMORY MAP			
Bit	Name	Function	Comment
23	<i>otp2.7</i>	<i>otp_en_SpreadCycle</i>	This flag determines if the driver defaults to <i>SpreadCycle</i> or to <i>StealthChop</i> .
			0 Default: <i>StealthChop</i> (<i>GCONF.en_SpreadCycle</i> =0) OTP 1.0 to 1.7 and 2.0 used for <i>StealthChop</i> <i>SpreadCycle</i> settings: <i>HEND</i> =0; <i>HSTART</i> =5; <i>TOFF</i> =3
			1 Default: <i>SpreadCycle</i> (<i>GCONF.en_SpreadCycle</i> =1) OTP 1.0 to 1.7 and 2.0 used for <i>SpreadCycle</i> <i>StealthChop</i> settings: <i>PWM_GRAD</i> =0; <i>TPWM_THRS</i> =0; <i>PWM_OFS</i> =36; <i>pwm_autograd</i> =1
22	<i>otp2.6</i>	<i>OTP_IHOLD</i>	Reset default for standstill current <i>IHOLD</i> (used only if current reduction enabled, e.g. pin PDN_UART low). %00: <i>IHOLD</i> = 16 (53% of <i>IRUN</i>) %01: <i>IHOLD</i> = 2 (9% of <i>IRUN</i>) %10: <i>IHOLD</i> = 8 (28% of <i>IRUN</i>) %11: <i>IHOLD</i> = 24 (78% of <i>IRUN</i>) (Reset default for run current <i>IRUN</i> =31)
21	<i>otp2.5</i>		
20	<i>otp2.4</i>	<i>OTP_IHOLDDELAY</i>	Reset default for <i>IHOLDDELAY</i> %00: <i>IHOLDDELAY</i> = 1 %01: <i>IHOLDDELAY</i> = 2 %10: <i>IHOLDDELAY</i> = 4 %11: <i>IHOLDDELAY</i> = 8
19	<i>otp2.3</i>		
18	<i>otp2.2</i>	<i>otp_PWM_FREQ</i>	Reset default for <i>PWM_FREQ</i> : 0: <i>PWM_FREQ</i> =%01=2/683 1: <i>PWM_FREQ</i> =%10=2/512
17	<i>otp2.1</i>	<i>otp_PWM_REG</i>	Reset default for <i>PWM_REG</i> : 0: <i>PWM_REG</i> =%1000: max. 4 increments / cycle 1: <i>PWM_REG</i> =%0010: max. 1 increment / cycle
16	<i>otp2.0</i>	<i>otp_PWM_OFS</i>	Depending on <i>otp_en_SpreadCycle</i> 0 0: <i>PWM_OFS</i> =36 1: <i>PWM_OFS</i> =00 (no feed forward scaling); <i>pwm_autograd</i> =0
		<i>OTP_CHOPCONF8</i>	1 Reset default for <i>CHOPCONF.8</i> (<i>hend1</i>)
15	<i>otp1.7</i>	<i>OTP_TPWMTHRS</i>	Depending on <i>otp_en_SpreadCycle</i>
14	<i>otp1.6</i>		0 Reset default for <i>TPWM_THRS</i> as defined by (0..7): 0: <i>TPWM_THRS</i> = 0 1: <i>TPWM_THRS</i> = 200 2: <i>TPWM_THRS</i> = 300 3: <i>TPWM_THRS</i> = 400 4: <i>TPWM_THRS</i> = 500 5: <i>TPWM_THRS</i> = 800 6: <i>TPWM_THRS</i> = 1200 7: <i>TPWM_THRS</i> = 4000
13	<i>otp1.5</i>		
		<i>OTP_CHOPCONF7...5</i>	1 Reset default for <i>CHOPCONF.5</i> to <i>CHOPCONF.7</i> (<i>hstrt1</i> , <i>hstrt2</i> and <i>hend0</i>)
12	<i>otp1.4</i>	<i>otp_pwm_autograd</i>	Depending on <i>otp_en_SpreadCycle</i>
			0 0: <i>pwm_autograd</i> =1 1: <i>pwm_autograd</i> =0

0x05: OTP_READ – OTP MEMORY MAP			
Bit	Name	Function	Comment
		OTP_CHOPCONF4	1 Reset default for CHOPCONF.4 (<i>hstrt0</i>); (<i>pwm_autograd=1</i>)
11	otp1.3	OTP_PWM_GRAD	Depending on <i>otp_en_SpreadCycle</i> 0 Reset default for <i>PWM_GRAD</i> as defined by (0..15): 0: <i>PWM_GRAD</i> = 14 1: <i>PWM_GRAD</i> = 16 2: <i>PWM_GRAD</i> = 18 3: <i>PWM_GRAD</i> = 21 4: <i>PWM_GRAD</i> = 24 5: <i>PWM_GRAD</i> = 27 6: <i>PWM_GRAD</i> = 31 7: <i>PWM_GRAD</i> = 35 8: <i>PWM_GRAD</i> = 40 9: <i>PWM_GRAD</i> = 46 10: <i>PWM_GRAD</i> = 52 11: <i>PWM_GRAD</i> = 59 12: <i>PWM_GRAD</i> = 67 13: <i>PWM_GRAD</i> = 77 14: <i>PWM_GRAD</i> = 88 15: <i>PWM_GRAD</i> = 100
10	otp1.2		
9	otp1.1		
8	otp1.0		
		OTP_CHOPCONF3...0	1 Reset default for CHOPCONF.0 to CHOPCONF.3 (TOFF)
7	otp0.7	otp_TBL	Reset default for TBL: 0: TBL=%10 1: TBL=%01
6	otp0.6	otp_internalRsense	Reset default for <i>GCONF.internal_Rsense</i> 0: External sense resistors 1: Internal sense resistors
5	otp0.5	otp_OTTRIM	Reset default for OTTRIM: 0: OTTRIM= %00 (143°C) 1: OTTRIM= %01 (150°C) (internal power stage temperature about 10°C above the sensor temperature limit)
4	otp0.4	OTP_FCLKTRIM	Reset default for FCLKTRIM 0: lowest frequency setting 31: highest frequency setting <i>Attention: This value is pre-programmed by factory clock trimming to the default clock frequency of 12MHz and differs between individual ICs! It should not be altered.</i>
3	otp0.3		
2	otp0.2		
1	otp0.1		
0	otp0.0		

5.2 Velocity Dependent Control

VELOCITY DEPENDENT DRIVER FEATURE CONTROL REGISTER SET (0x10...0x1F)				
R/W	Addr	n	Register	Description / bit names
W	0x10	5 + 5 + 4	IHOLD_IRUN	Bit 4..0 <i>I</i> HOLD (<i>Reset default: OTP</i>) Standstill current (0=1/32 ... 31=32/32) In combination with StealthChop mode, setting <i>I</i> HOLD=0 allows to choose freewheeling or coil short circuit (passive braking) for motor stand still.
				12..8 <i>I</i> RUN (<i>Reset default=31</i>) Motor run current (0=1/32 ... 31=32/32) <i>Hint: Choose sense resistors in a way, that normal IRUN is 16 to 31 for best microstep performance.</i>
				19..16 <i>I</i> HOLDDELAY (<i>Reset default: OTP</i>) Controls the number of clock cycles for motor power down after standstill is detected (<i>stst=1</i>) and <i>T</i> POWERDOWN has expired. The smooth transition avoids a motor jerk upon power down. 0: instant power down 1..15: Delay per current reduction step in multiple of 2 ¹⁸ clocks
W	0x11	8	<i>T</i> POWERDOWN	<i>T</i> POWERDOWN (<i>Reset default=20</i>) Sets the delay time from stand still (<i>stst</i>) detection to motor current power down. Time range is about 0 to 5.6 seconds. $0 \dots ((2^8)-1) * 2^{18} t_{CLK}$ <i>Attention: A minimum setting of 2 is required to allow automatic tuning of StealthChop PWM_OFFS_AUTO.</i>
R	0x12	20	<i>T</i> STEP	Actual measured time between two 1/256 microsteps derived from the step input frequency in units of 1/fCLK. Measured value is (2 ²⁰)-1 in case of overflow or stand still. The <i>T</i> STEP related threshold uses a hysteresis of 1/16 of the compare value to compensate for jitter in the clock or the step frequency: (<i>T</i> xxx*15/16)-1 is the lower compare value for each <i>T</i> STEP based comparison. This means, that the lower switching velocity equals the calculated setting, but the upper switching velocity is higher as defined by the hysteresis setting.
W	0x13	20	<i>T</i> PWMTHRS	Sets the upper velocity for StealthChop voltage PWM mode. $TSTEP \geq TPWMTHRS$ - StealthChop PWM mode is enabled, if configured When the velocity exceeds the limit set by <i>T</i> PWMTHRS, the driver switches to SpreadCycle. 0: Disabled
W	0x22	24	<i>V</i> ACTUAL	<i>V</i> ACTUAL allows moving the motor by UART control. It gives the motor velocity in $\pm(2^{23})-1$ [μ steps / t] 0: Normal operation. Driver reacts to STEP input. !=0: Motor moves with the velocity given by <i>V</i> ACTUAL. Step pulses can be monitored via INDEX output. The motor direction is controlled by the sign of <i>V</i> ACTUAL.

5.3 StallGuard Control

COOLSTEP AND STALLGUARD CONTROL REGISTER SET (0x14, 0x40...0x42)				
R/W	Addr	n	Register	Description / bit names
W	0x14	20	TCOOLTHRS	<p>TCOOLTHRS This is the lower threshold velocity for switching on smart energy CoolStep and StallGuard to DIAG output. (unsigned) Set this parameter to disable CoolStep at low speeds, where it cannot work reliably. The stall output signal become enabled when exceeding this velocity. It becomes disabled again once the velocity falls below this threshold. $TCOOLTHRS \geq TSTEP > TPWMTHRS$ - CoolStep is enabled, if configured (only with StealthChop) - Stall output signal on pin DIAG is enabled</p>
W	0x40	8	SGTHRS	<p>SGTHRS Detection threshold for stall. The StallGuard value <i>SG_RESULT</i> becomes compared to the double of this threshold. A stall is signaled with $SG_RESULT \leq SGTHRS * 2$</p>
R	0x41	10	SG_RESULT	<p>StallGuard result. <i>SG_RESULT</i> becomes updated with each fullstep, independent of <i>TCOOLTHRS</i> and <i>SGTHRS</i>. A higher value signals a lower motor load and more torque headroom. Intended for StealthChop mode, only. Bits 9 and 0 will always show 0. Scaling to 10 bit is for compatibility to StallGuard2.</p>
W	0x42	16	COOLCONF	<p>CoolStep configuration <i>See separate table!</i></p>

SKYTECH
ELECTRONIC

5.3.1 COOLCONF – Smart Energy Control CoolStep

0x42: COOLCONF – SMART ENERGY CONTROL COOLSTEP AND STALLGUARD2			
Bit	Name	Function	Comment
...			
15	<i>seimin</i>	minimum current for smart current control	0: 1/2 of current setting (<i>IRUN</i>) 1: 1/4 of current setting (<i>IRUN</i>)
14	<i>sedn1</i>	current down step speed	%00: For each 32 StallGuard4 values decrease by one %01: For each 8 StallGuard4 values decrease by one %10: For each 2 StallGuard4 values decrease by one %11: For each StallGuard4 value decrease by one
13	<i>sedn0</i>		
12	-	reserved	set to 0
11	<i>semax3</i>	StallGuard2 hysteresis value for smart current control	If the StallGuard4 result is equal to or above (<i>SEMIN+SEMAX+1</i>)*32, the motor current becomes decreased to save energy. %0000 ... %1111: 0 ... 15
10	<i>semax2</i>		
9	<i>semax1</i>		
8	<i>semax0</i>		
7	-	reserved	set to 0
6	<i>seup1</i>	current up step width	Current increment steps per measured StallGuard2 value %00 ... %11: 1, 2, 4, 8
5	<i>seup0</i>		
4	-	reserved	set to 0
3	<i>semin3</i>	minimum StallGuard2 value for smart current control and smart current enable	If the StallGuard4 result falls below <i>SEMIN</i> *32, the motor current becomes increased to reduce motor load angle. %0000: smart current control CoolStep off %0001 ... %1111: 1 ... 15
2	<i>semin2</i>		
1	<i>semin1</i>		
0	<i>semin0</i>		

SKYTECH
ELECTRONIC

5.4 Sequencer Registers

The sequencer registers have a pure informative character and are read-only. They help for special cases like storing the last motor position before power off in battery powered applications.

MICROSTEPPING CONTROL REGISTER SET (0x60...0x6B)					
R/W	Addr	n	Register	Description / bit names	Range [Unit]
R	0x6A	10	MSCNT	Microstep counter. Indicates actual position in the microstep table for <i>CUR_A</i> . <i>CUR_B</i> uses an offset of 256 into the table. Reading out <i>MSCNT</i> allows determination of the motor position within the electrical wave.	0...1023
R	0x6B	9 + 9	MSCURACT	bit 8... 0: <i>CUR_A</i> (signed): Actual microstep current for motor phase A as read from the internal sine wave table (not scaled by current setting) bit 24... 16: <i>CUR_B</i> (signed): Actual microstep current for motor phase B as read from the internal sine wave table (not scaled by current setting)	+/-0...255

SKYTECH
ELECTRONIC

5.5 Chopper Control Registers

DRIVER REGISTER SET (0x6C...0x7F)						
R/W	Addr	n	Register	Description / bit names	Range [Unit]	
RW	0x6C	32	CHOPCONF	Chopper and driver configuration <i>See separate table!</i>	Reset default= 0x10000053	
R	0x6F	32	DRV_STATUS	Driver status flags and current level read back <i>See separate table!</i>		
RW	0x70	22	PWMCONF	StealthChop PWM chopper configuration <i>See separate table!</i>	Reset default= 0xC10D0024	
R	0x71	9+8	PWM_SCALE	Results of StealthChop amplitude regulator. These values can be used to monitor automatic PWM amplitude scaling (255=max. voltage).		
				bit 7... 0	PWM_SCALE_SUM: Actual PWM duty cycle. This value is used for scaling the values <i>CUR_A</i> and <i>CUR_B</i> read from the sine wave table.	0...255
				bit 24... 16	PWM_SCALE_AUTO: 9 Bit signed offset added to the calculated PWM duty cycle. This is the result of the automatic amplitude regulation based on current measurement.	signed -255...+255
R	0x72	8+8	PWM_AUTO	These automatically generated values can be read out in order to determine a default / power up setting for <i>PWM_GRAD</i> and <i>PWM_OFS</i> .		
				bit 7... 0	PWM_OFS_AUTO: Automatically determined offset value	0...255
				bit 23... 16	PWM_GRAD_AUTO: Automatically determined gradient value	0...255

SKY TECH
ELECTRONIC

5.5.1 CHOPCONF – Chopper Configuration

0x6C: CHOPCONF – CHOPPER CONFIGURATION			
Bit	Name	Function	Comment
31	<i>diss2vs</i>	Low side short protection disable	0: Short protection low side is on 1: Short protection low side is disabled
30	<i>diss2g</i>	short to GND protection disable	0: Short to GND protection is on 1: Short to GND protection is disabled
29	<i>dedge</i>	enable double edge step pulses	1: Enable step impulse at each step edge to reduce step frequency requirement. This mode is not compatible with the step filtering function (<i>multistep_filt</i>)
28	<i>intpol</i>	interpolation to 256 microsteps	1: The actual microstep resolution (<i>MRES</i>) becomes extrapolated to 256 microsteps for smoothest motor operation. (Default: 1)
27	<i>mres3</i>	<i>MRES</i> micro step resolution	%0000: Native 256 microstep setting. %0001 ... %1000: 128, 64, 32, 16, 8, 4, 2, FULLSTEP Reduced microstep resolution. The resolution gives the number of microstep entries per sine quarter wave. When choosing a lower microstep resolution, the driver automatically uses microstep positions which result in a symmetrical wave. Number of microsteps per step pulse = 2^{MRES} (Selection by pins unless disabled by <i>GCONF.mstep_reg_select</i>)
26	<i>mres2</i>		
25	<i>mres1</i>		
24	<i>mres0</i>		
23	-	reserved	set to 0
22			
21			
20			
19			
18			
17	<i>vsense</i>	sense resistor voltage based current scaling	0: Low sensitivity, high sense resistor voltage 1: High sensitivity, low sense resistor voltage
16	<i>tbl1</i>	<i>TBL</i> blank time select	%00 ... %11: Set comparator blank time to 16, 24, 32 or 40 clocks <i>Hint</i> : %00 or %01 is recommended for most applications (Default: OTP)
15	<i>tbl0</i>		
14	-	reserved	set to 0
13			
12			
11			
10	<i>hend3</i>		
9	<i>hend2</i>	<i>HEND</i> hysteresis low value <i>OFFSET</i>	%0000 ... %1111: Hysteresis is -3, -2, -1, 0, 1, ..., 12 (1/512 of this setting adds to current setting)
8	<i>hend1</i>		
7	<i>hend0</i>	sine wave offset	This is the hysteresis value which becomes used for the hysteresis chopper. (Default: OTP, resp. 5 in StealthChop mode)
6	<i>hstrt2</i>	<i>HSTRT</i> hysteresis start value added to <i>HEND</i>	%000 ... %111: Add 1, 2, ..., 8 to hysteresis low value <i>HEND</i> (1/512 of this setting adds to current setting) <i>Attention</i> : $Effective\ HEND+HSTRT \leq 16$. <i>Hint</i> : Hysteresis decrement is done each 16 clocks
5	<i>hstrt1</i>		
4	<i>hstrt0</i>		

0x6C: CHOPCONF – CHOPPER CONFIGURATION			
Bit	Name	Function	Comment
			(Default: OTP, resp. 0 in StealthChop mode)
3	<i>toff3</i>	TOFF off time and driver enable	Off time setting controls duration of slow decay phase $N_{CLK} = 24 + 32 * TOFF$ %0000: Driver disable, all bridges off %0001: 1 – use only with $TBL \geq 2$ %0010 ... %1111: 2 ... 15 (Default: OTP, resp. 3 in StealthChop mode)
2	<i>toff2</i>		
1	<i>toff1</i>		
0	<i>toff0</i>		



5.5.2 PWMCONF – Voltage PWM Mode StealthChop

0x70: PWMCONF – VOLTAGE MODE PWM STEALTHCHOP				
Bit	Name	Function	Comment	
31	PWM_LIM	PWM automatic scale amplitude limit when switching on	Limit for <i>PWM_SCALE_AUTO</i> when switching back from SpreadCycle to StealthChop. This value defines the upper limit for bits 7 to 4 of the automatic current control when switching back. It can be set to reduce the current jerk during mode change back to StealthChop. It does not limit <i>PWM_GRAD</i> or <i>PWM_GRAD_AUTO</i> offset. (Default = 12)	
30				
29				
28				
27	PWM_REG	Regulation loop gradient	User defined maximum PWM amplitude change per half wave when using <i>pwm_autoscale=1</i> . (1...15): 1: 0.5 increments (slowest regulation) 2: 1 increment (default with <i>OTP2.1=1</i>) 3: 1.5 increments 4: 2 increments ... 8: 4 increments (default with <i>OTP2.1=0</i>) ... 15: 7.5 increments (fastest regulation)	
26				
25				
24				
23	-	reserved	set to 0	
22	-	reserved	set to 0	
21	<i>freewheel1</i>	Allows different standstill modes	Stand still option when motor current setting is zero (<i>I_HOLD=0</i>). %00: Normal operation %01: Freewheeling %10: Coil shorted using LS drivers %11: Coil shorted using HS drivers	
20	<i>freewheel0</i>			
19	<i>pwm_autograd</i>	PWM automatic gradient adaptation	0	Fixed value for <i>PWM_GRAD</i> (<i>PWM_GRAD_AUTO</i> = <i>PWM_GRAD</i>)
			1	Automatic tuning (only with <i>pwm_autoscale=1</i>) <i>PWM_GRAD_AUTO</i> is initialized with <i>PWM_GRAD</i> and becomes optimized automatically during motion. <u>Preconditions</u> 1. <i>PWM_OFS_AUTO</i> has been automatically initialized. This requires standstill at <i>IRUN</i> for >130ms in order to a) detect standstill b) wait > 128 chopper cycles at <i>IRUN</i> and c) regulate <i>PWM_OFS_AUTO</i> so that $-1 < PWM_SCALE_AUTO < 1$ 2. Motor running and $1.5 * PWM_OFS_AUTO < PWM_SCALE_SUM < 4 * PWM_OFS_AUTO$ and $PWM_SCALE_SUM < 255$. <u>Time required for tuning <i>PWM_GRAD_AUTO</i></u> About 8 fullsteps per change of +/-1.
18	<i>pwm_autoscale</i>	PWM automatic amplitude scaling	0	User defined feed forward PWM amplitude. The current settings <i>IRUN</i> and <i>I_HOLD</i> have no influence! The resulting PWM amplitude (limited to 0...255) is: $PWM_OFS * ((CS_ACTUAL+1) / 32) + PWM_GRAD * 256 / TSTEP$
			1	Enable automatic current control (<i>Reset default</i>)
17	<i>pwm_freq1</i>	PWM frequency	%00: $f_{PWM}=2/1024 f_{CLK}$	

0x70: PWMCONF – VOLTAGE MODE PWM STEALTHCHOP			
Bit	Name	Function	Comment
16	<i>pwm_freq0</i>	selection	%01: $f_{PWM}=2/683 f_{CLK}$ %10: $f_{PWM}=2/512 f_{CLK}$ %11: $f_{PWM}=2/410 f_{CLK}$
15	<i>PWM_GRAD</i>	User defined amplitude gradient	Velocity dependent gradient for PWM amplitude: $PWM_GRAD * 256 / TSTEP$ This value is added to <i>PWM_AMPL</i> to compensate for the velocity-dependent motor back-EMF. With automatic scaling (<i>pwm_autoscale=1</i>) the value is used for first initialization, only. Set <i>PWM_GRAD</i> to the application specific value (it can be read out from <i>PWM_GRAD_AUTO</i>) to speed up the automatic tuning process. An approximate value can be stored to OTP by programming <i>OTP_PWM_GRAD</i> .
14			
13			
12			
11			
10			
9			
8			
7	<i>PWM_OFS</i>	User defined amplitude (offset)	User defined PWM amplitude offset (0-255) related to full motor current (<i>CS_ACTUAL=31</i>) in stand still. (Reset default=36) When using automatic scaling (<i>pwm_autoscale=1</i>) the value is used for initialization, only. The autoscale function starts with $PWM_SCALE_AUTO=PWM_OFS$ and finds the required offset to yield the target current automatically. <i>PWM_OFS = 0</i> will disable scaling down motor current below a motor specific lower measurement threshold. This setting should only be used under certain conditions, i.e. when the power supply voltage can vary up and down by a factor of two or more. It prevents the motor going out of regulation, but it also prevents power down below the regulation limit. <i>PWM_OFS > 0</i> allows automatic scaling to low PWM duty cycles even below the lower regulation threshold. This allows low (standstill) current settings based on the actual (hold) current scale (register <i>IHOLD_IRUN</i>).
6			
5			
4			
3			
2			
1			
0			

5.5.3 DRV_STATUS – Driver Status Flags

0x6F: DRV_STATUS – DRIVER STATUS FLAGS AND CURRENT LEVEL READ BACK			
Bit	Name	Function	Comment
31	<i>stst</i>	standstill indicator	This flag indicates motor stand still in each operation mode. This occurs 2 ²⁰ clocks after the last step pulse.
30	<i>stealth</i>	StealthChop indicator	1: Driver operates in StealthChop mode 0: Driver operates in SpreadCycle mode
29	-	reserved	Ignore these bits.
28			
27			
26			
25			
24			
23	-	reserved	Ignore these bits.
22			
21			
20	<i>CS_</i> <i>ACTUAL</i>	actual motor current / smart energy current	Actual current control scaling, for monitoring the function of the automatic current scaling.
19			
18			
17			
16			
15			
14			
13			
12			
11	<i>t157</i>	157°C comparator	1: Temperature threshold is exceeded
10	<i>t150</i>	150°C comparator	1: Temperature threshold is exceeded
9	<i>t143</i>	143°C comparator	1: Temperature threshold is exceeded
8	<i>t120</i>	120°C comparator	1: Temperature threshold is exceeded
7	<i>olb</i>	open load indicator phase B	1: Open load detected on phase A or B. <i>Hint:</i> This is just an informative flag. The driver takes no action upon it. False detection may occur in fast motion and standstill. Check during slow motion, only.
6	<i>ola</i>	open load indicator phase A	
5	<i>s2vsb</i>	low side short indicator phase B	1: Short on low-side MOSFET detected on phase A or B. The driver becomes disabled. The flags stay active, until the driver is disabled by software (TOFF=0) or by the ENN input. Flags are separate for both chopper modes.
4	<i>s2vsa</i>	low side short indicator phase A	
3	<i>s2gb</i>	short to ground indicator phase B	1: Short to GND detected on phase A or B. The driver becomes disabled. The flags stay active, until the driver is disabled by software (TOFF=0) or by the ENN input. Flags are separate for both chopper modes.
2	<i>s2ga</i>	short to ground indicator phase A	
1	<i>ot</i>	overtemperature flag	1: The selected overtemperature limit has been reached. Drivers become disabled until <i>otpw</i> is also cleared due to cooling down of the IC. The overtemperature flag is common for both bridges.
0	<i>otpw</i>	overtemperature pre- warning flag	1: The selected overtemperature pre-warning threshold is exceeded. The overtemperature pre-warning flag is common for both bridges.

6 StealthChop™



StealthChop is an extremely quiet mode of operation for stepper motors. It is based on a voltage mode PWM. In case of standstill and at low velocities, the motor is absolutely noiseless. Thus, StealthChop operated stepper motor applications are very suitable for indoor or home use. The motor operates absolutely free of vibration at low velocities.

With StealthChop, the motor current is applied by driving a certain effective voltage into the coil, using a voltage mode PWM. With the enhanced StealthChop2, the driver automatically adapts to the application for best performance. No more configurations are required. Optional configuration allows for tuning the setting in special cases, or for storing initial values for the automatic adaptation algorithm. For high velocity consider SpreadCycle in combination with StealthChop.

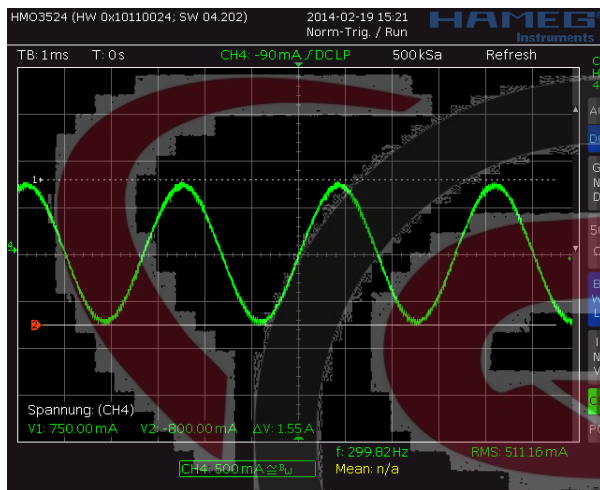

Figure 6.1 Motor coil sine wave current with StealthChop (measured with current probe)

6.1 Automatic Tuning

StealthChop2 integrates an automatic tuning procedure (AT), which adapts the most important operating parameters to the motor automatically. This way, StealthChop2 allows high motor dynamics and supports powering down the motor to very low currents. Just two steps have to be respected by the motion controller for best results: Start with the motor in standstill, but powered with nominal run current (AT#1). Move the motor at a medium velocity, e.g. as part of a homing procedure (AT#2). Figure 6.2 shows the tuning procedure.

Border conditions in for AT#1 and AT#2 are shown in the following table:

AUTOMATIC TUNING TIMING AND BORDER CONDITIONS			
Step	Parameter	Conditions	Duration
AT#1	<code>PWM_OFS_AUTO</code>	<ul style="list-style-type: none"> - Motor in standstill and actual current scale (CS) is identical to run current (<code>IRUN</code>). - If standstill reduction is enabled (pin <code>PDN_UART=0</code>), an initial step pulse switches the drive back to run current. - Pins VS and VREF at operating level. 	$\leq 2^{20} + 2^{2 \cdot 18} t_{CLK}$, $\leq 130\text{ms}$ (with internal clock)
AT#2	<code>PWM_GRAD_AUTO</code>	<ul style="list-style-type: none"> - Motor must move at a velocity, where a significant amount of back EMF is generated and where the full run current can be reached. Conditions: <ul style="list-style-type: none"> - $1.5 * PWM_OFS_AUTO < PWM_SCALE_SUM < 4 * PWM_OFS_AUTO$ - $PWM_SCALE_SUM < 255$. <p><i>Hint: A typical range is 60-300 RPM. Determine best conditions with the evaluation board and monitor <code>PWM_SCALE_AUTO</code> going down to zero during tuning.</i></p>	8 fullsteps are required for a change of +/-1. For a typical motor with <code>PWM_GRAD_AUTO</code> optimum at 64 or less, up to 400 fullsteps are required when starting from OTP default 14.

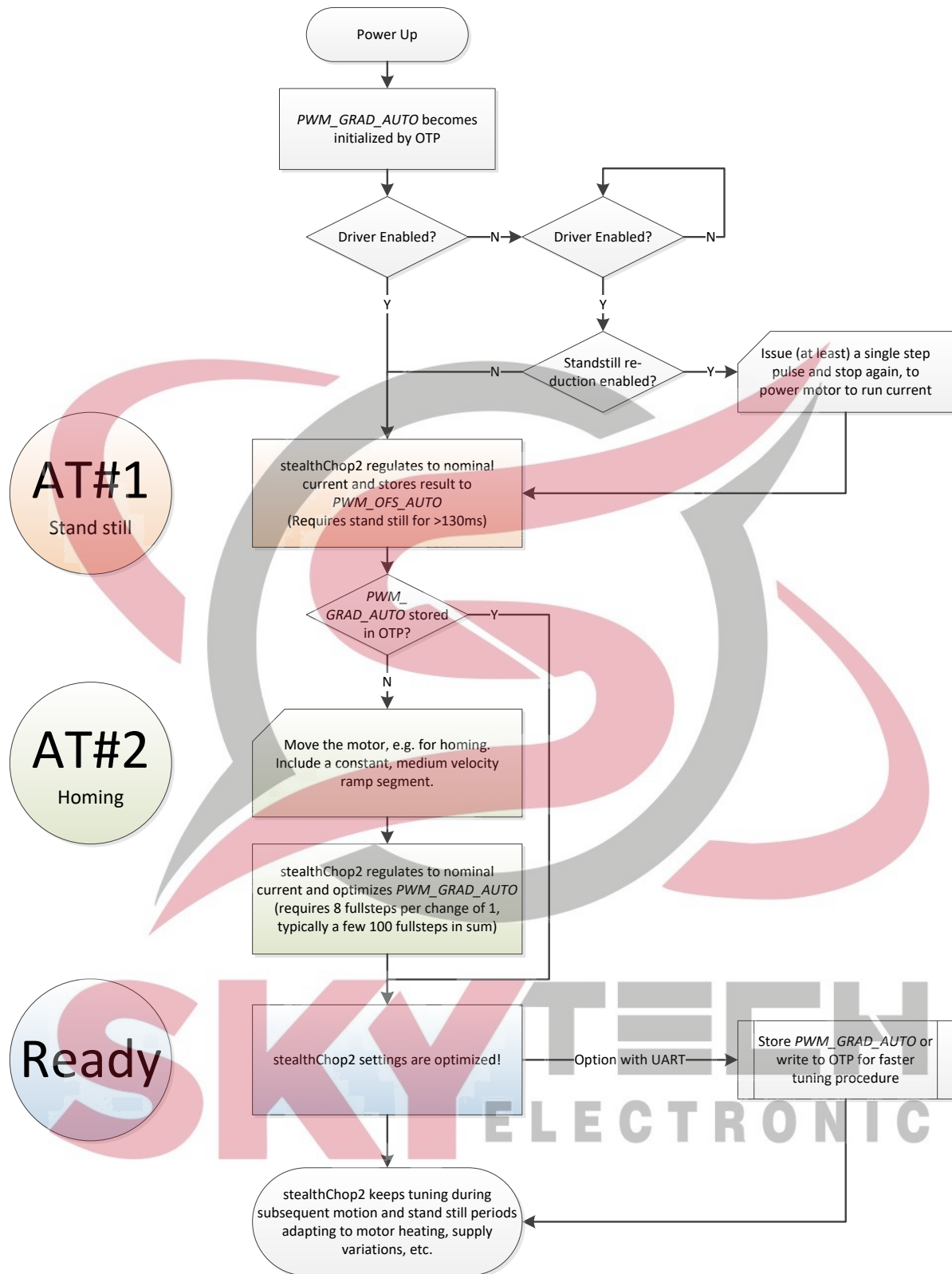

Figure 6.2 StealthChop2 automatic tuning procedure

Attention

Modifying VREF or the supply voltage VS invalidates the result of the automatic tuning process. Motor current regulation cannot compensate significant changes until next AT#1 phase. Automatic tuning adapts to changed conditions whenever AT#1 and AT#2 conditions are fulfilled in the later operation.



6.2 StealthChop Options

In order to match the motor current to a certain level, the effective PWM voltage becomes scaled depending on the actual motor velocity. Several additional factors influence the required voltage level to drive the motor at the target current: The motor resistance, its back EMF (i.e. directly proportional to its velocity) as well as the actual level of the supply voltage. Two modes of PWM regulation are provided: The automatic tuning mode (AT) using current feedback ($pwm_autoscale = 1$, $pwm_autograd = 1$) and a feed forward velocity-controlled mode ($pwm_autoscale = 0$). The feed forward velocity-controlled mode will not react to a change of the supply voltage or to events like a motor stall, but it provides very stable amplitude. It does not use nor require any means of current measurement. This is perfect when motor type and supply voltage are well known. Therefore, we recommend the automatic mode, unless current regulation is not satisfying in the given operating conditions.

It is recommended to operate in automatic tuning mode.

Non-automatic mode ($pwm_autoscale=0$) should be considered only with well-known motor and operating conditions. In this case, programming via the UART interface is required. The operating parameters PWM_GRAD and PWM_OFS can be determined in automatic tuning mode initially.

Hint: In non-automatic mode the power supply current directly reflects mechanical load on the motor.

The StealthChop PWM frequency can be chosen in four steps in order to adapt the frequency divider to the frequency of the clock source. A setting in the range of 20-50kHz is good for most applications. It balances low current ripple and good higher velocity performance vs. dynamic power dissipation.

CHOICE OF PWM FREQUENCY FOR STEALTHCHOP				
Clock frequency f_{CLK}	$PWM_FREQ=\%00$ $f_{PWM}=2/1024 f_{CLK}$	$PWM_FREQ=\%01$ $f_{PWM}=2/683 f_{CLK}$ (default)	$PWM_FREQ=\%10$ $f_{PWM}=2/512 f_{CLK}$ (OTP option)	$PWM_FREQ=\%11$ $f_{PWM}=2/410 f_{CLK}$
18MHz	35.2kHz	52.7kHz	70.3kHz	87.8kHz
16MHz	31.3kHz	46.9kHz	62.5kHz	78.0kHz
12MHz (internal)	23.4kHz	35.1kHz	46.9kHz	58.5kHz
10MHz	19.5kHz	29.3kHz	39.1kHz	48.8kHz
8MHz	15.6kHz	23.4kHz	31.2kHz	39.0kHz

Table 6.1 Choice of PWM frequency – green / light green: recommended

6.3 StealthChop Current Regulator

In StealthChop voltage PWM mode, the autoscaling function ($pwm_autoscale = 1$, $pwm_autograd = 1$) regulates the motor current to the desired current setting. Automatic scaling is used as part of the automatic tuning process (AT), and for subsequent tracking of changes within the motor parameters. The driver measures the motor current during the chopper on time and uses a proportional regulator to regulate PWM_SCALE_AUTO in order match the motor current to the target current. PWM_REG is the proportionality coefficient for this regulator. Basically, the proportionality coefficient should be as small as possible in order to get a stable and soft regulation behavior, but it must be large enough to allow the driver to quickly react to changes caused by variation of the motor target current (e.g. change of $VREF$). During initial tuning step AT#2, PWM_REG also compensates for the change of motor velocity. Therefore, a high acceleration during AT#2 will require a higher setting of PWM_REG . With careful selection of homing velocity and acceleration, a minimum setting of the regulation gradient often is sufficient ($PWM_REG=1$). PWM_REG setting should be optimized for the fastest required acceleration and deceleration ramp (compare Figure 6.3 and Figure 6.4). The quality of the setting PWM_REG in phase AT#2 and the finished automatic tuning procedure (or non-automatic settings for PWM_OFS and PWM_GRAD) can be examined when monitoring motor current during an acceleration phase Figure 6.5.

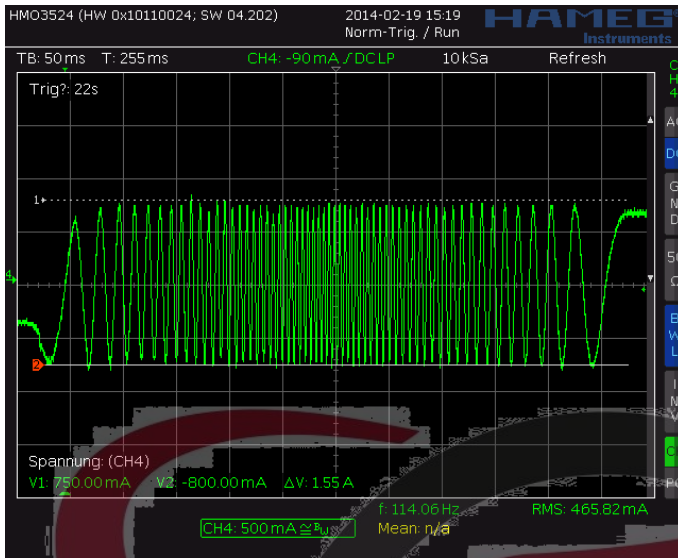

Figure 6.3 Scope shot: good setting for PWM_REG

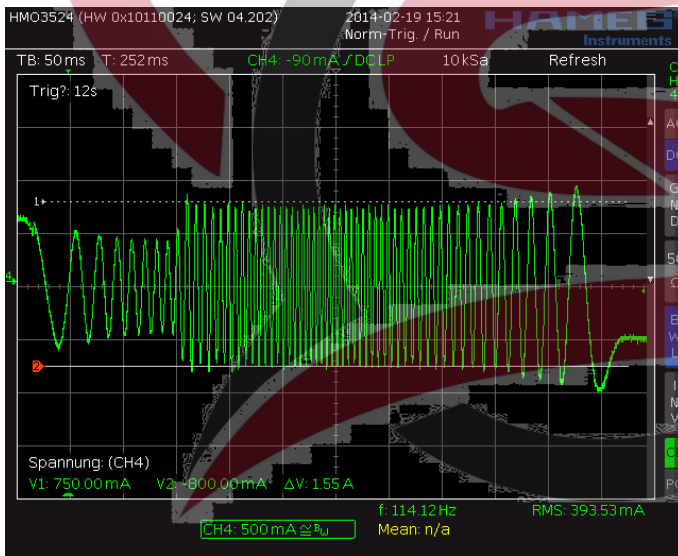

Figure 6.4 Scope shot: too small setting for PWM_REG during AT#2

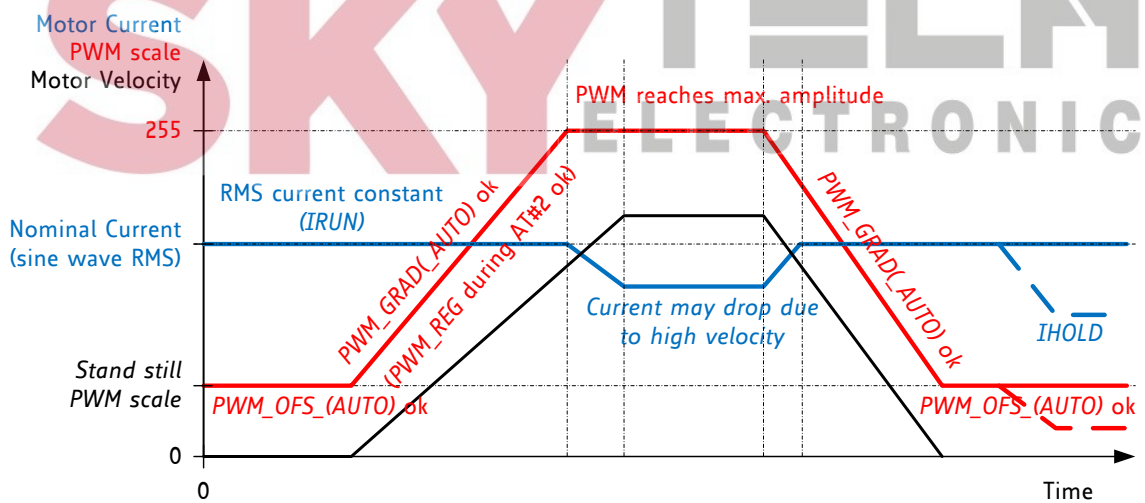

Figure 6.5 Successfully determined PWM_GRAD(AUTO) and PWM_OFS(AUTO)

Quick Start

For a quick start, see the Quick Configuration Guide in chapter 16.

6.3.1 Lower Current Limit

The StealthChop current regulator imposes a lower limit for motor current regulation. As the coil current can be measured in the shunt resistor during chopper on phase only, a minimum chopper duty cycle allowing coil current regulation is given by the blank time as set by *TBL* and by the chopper frequency setting. Therefore, the motor specific minimum coil current in StealthChop autoscaling mode rises with the supply voltage and with the chopper frequency. A lower blanking time allows a lower current limit. It is important for the correct determination of *PWM_OFS_AUTO*, that in AT#1 the run current set by the sense resistor, *VREF* and *IRUN* is well within the regulation range. Lower currents (e.g. for standstill power down) are automatically realized based on *PWM_OFS_AUTO* and *PWM_GRAD_AUTO* respectively based on *PWM_OFS* and *PWM_GRAD* with non-automatic current scaling. The freewheeling option allows going to zero motor current.

Lower motor coil current limit for StealthChop2 automatic tuning:

$$I_{\text{Lower Limit}} = t_{\text{BLANK}} * f_{\text{PWM}} * \frac{V_M}{R_{\text{COIL}}}$$

With V_M the motor supply voltage and R_{COIL} the motor coil resistance.

$I_{\text{Lower Limit}}$ can be treated as a thumb value for the minimum nominal *IRUN* motor current setting.

EXAMPLE:

A motor has a coil resistance of 5Ω, the supply voltage is 24V. With *TBL*=%01 and *PWM_FREQ*=%00, t_{BLANK} is 24 clock cycles, f_{PWM} is 2/(1024 clock cycles):

$$I_{\text{Lower Limit}} = 24 t_{\text{CLK}} * \frac{2}{1024 t_{\text{CLK}}} * \frac{24V}{5\Omega} = \frac{24}{512} * \frac{24V}{5\Omega} = 225mA$$

This means, the motor target current for automatic tuning must be 225mA or more, taking into account all relevant settings. This lower current limit also applies for modification of the motor current via the analog input *VREF*.

Attention

For automatic tuning, a lower coil current limit applies. The motor current in automatic tuning phase AT#1 must exceed this lower limit. $I_{\text{LOWER LIMIT}}$ can be calculated or measured using a current probe. Setting the motor run-current or hold-current below the lower current limit during operation by modifying *IRUN* and *IHOLD* is possible after successful automatic tuning.

With StealthChop, ensure that *IRUN* is in the range 8 to 31. Set *vsense* to yield lower current setting!

The lower current limit also limits the capability of the driver to respond to changes of *VREF*.

6.4 Velocity Based Scaling

Velocity based scaling scales the StealthChop amplitude based on the time between each two steps, i.e. based on *TSTEP*, measured in clock cycles. This concept basically does not require a current measurement, because no regulation loop is necessary. A pure velocity-based scaling is available via UART programming, only, when setting *pwm_autoscale* = 0. The basic idea is to have a linear approximation of the voltage required to drive the target current into the motor. The stepper motor has a certain coil resistance and thus needs a certain voltage amplitude to yield a target current

based on the basic formula $I=U/R$. With R being the coil resistance, U the supply voltage scaled by the PWM value, the current I results. The initial value for PWM_AMPL can be calculated:

$$PWM_AMPL = \frac{374 * R_{COIL} * I_{COIL}}{V_M}$$

With V_M the motor supply voltage and I_{COIL} the target RMS current

The effective PWM voltage U_{PWM} ($1/\sqrt{2}$ x peak value) results considering the 8 bit resolution and 248 sine wave peak for the actual PWM amplitude shown as PWM_SCALE :

$$U_{PWM} = V_M * \frac{PWM_SCALE}{256} * \frac{248}{256} * \frac{1}{\sqrt{2}} = V_M * \frac{PWM_SCALE}{374}$$

With rising motor velocity, the motor generates an increasing back EMF voltage. The back EMF voltage is proportional to the motor velocity. It reduces the PWM voltage effective at the coil resistance and thus current decreases. The TMC2209 provides a second velocity dependent factor (PWM_GRAD) to compensate for this. The overall effective PWM amplitude (PWM_SCALE_SUM) in this mode automatically is calculated in dependence of the microstep frequency as:

$$PWM_SCALE_SUM = PWM_OFS + PWM_GRAD * 256 * \frac{f_{STEP}}{f_{CLK}}$$

With f_{STEP} being the microstep frequency for 256 microstep resolution equivalent and f_{CLK} the clock frequency supplied to the driver or the actual internal frequency

As a first approximation, the back EMF subtracts from the supply voltage and thus the effective current amplitude decreases. This way, a first approximation for PWM_GRAD setting can be calculated:

$$PWM_GRAD = C_{BEMF} \left[\frac{V}{\frac{rad}{s}} \right] * 2\pi * \frac{f_{CLK} * 1.46}{V_M * MSPR}$$

C_{BEMF} is the back EMF constant of the motor in Volts per radian/second.

$MSPR$ is the number of microsteps per rotation, e.g. 51200 = 256µsteps multiplied by 200 fullsteps for a 1.8° motor.

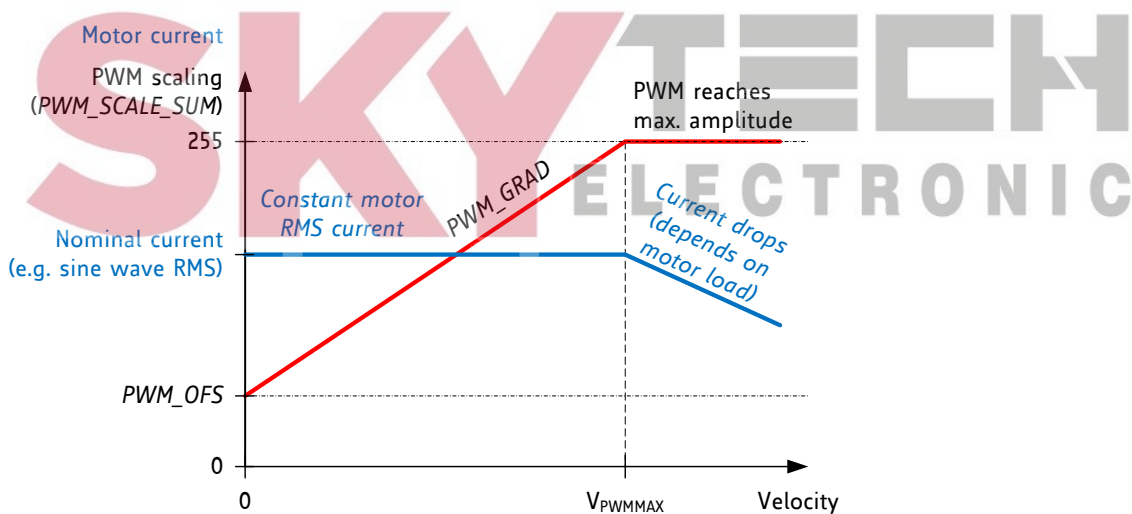

Figure 6.6 Velocity based PWM scaling (pwm_autoscale=0)

Hint

The values for *PWM_OFS* and *PWM_GRAD* can easily be optimized by tracing the motor current with a current probe on the oscilloscope. Alternatively, automatic tuning determines these values and they can be read out from *PWM_OFS_AUTO* and *PWM_GRAD_AUTO*.

UNDERSTANDING THE BACK EMF CONSTANT OF A MOTOR

The back EMF constant is the voltage a motor generates when turned with a certain velocity. Often motor datasheets do not specify this value, as it can be deduced from motor torque and coil current rating. Within SI units, the numeric value of the back EMF constant C_{BEMF} has the same numeric value as the numeric value of the torque constant. For example, a motor with a torque constant of 1 Nm/A would have a C_{BEMF} of 1V/rad/s. Turning such a motor with 1 rps (1 rps = 1 revolution per second = 6.28 rad/s) generates a back EMF voltage of 6.28V. Thus, the back EMF constant can be calculated as:

$$C_{BEMF} \left[\frac{V}{rad/s} \right] = \frac{HoldingTorque[Nm]}{2 * I_{COILNOM}[A]}$$

$I_{COILNOM}$ is the motor's rated phase current for the specified holding torque

HoldingTorque is the motor specific holding torque, i.e. the torque reached at $I_{COILNOM}$ on both coils. The torque unit is [Nm] where 1Nm = 100Ncm = 1000mNm.

The voltage is valid as RMS voltage per coil, thus the nominal current is multiplied by 2 in this formula, since the nominal current assumes a full step position, with two coils operating.

6.5 Combine StealthChop and SpreadCycle

For applications requiring high velocity motion, SpreadCycle may bring more stable operation in the upper velocity range. To combine no-noise operation with highest dynamic performance, the TMC2209 allows combining StealthChop and SpreadCycle based on a velocity threshold (Figure 6.7). A velocity threshold (*TPWMTHRS*) can be preprogrammed to OTP to support this mode even in standalone operation. With this, StealthChop is only active at low velocities.

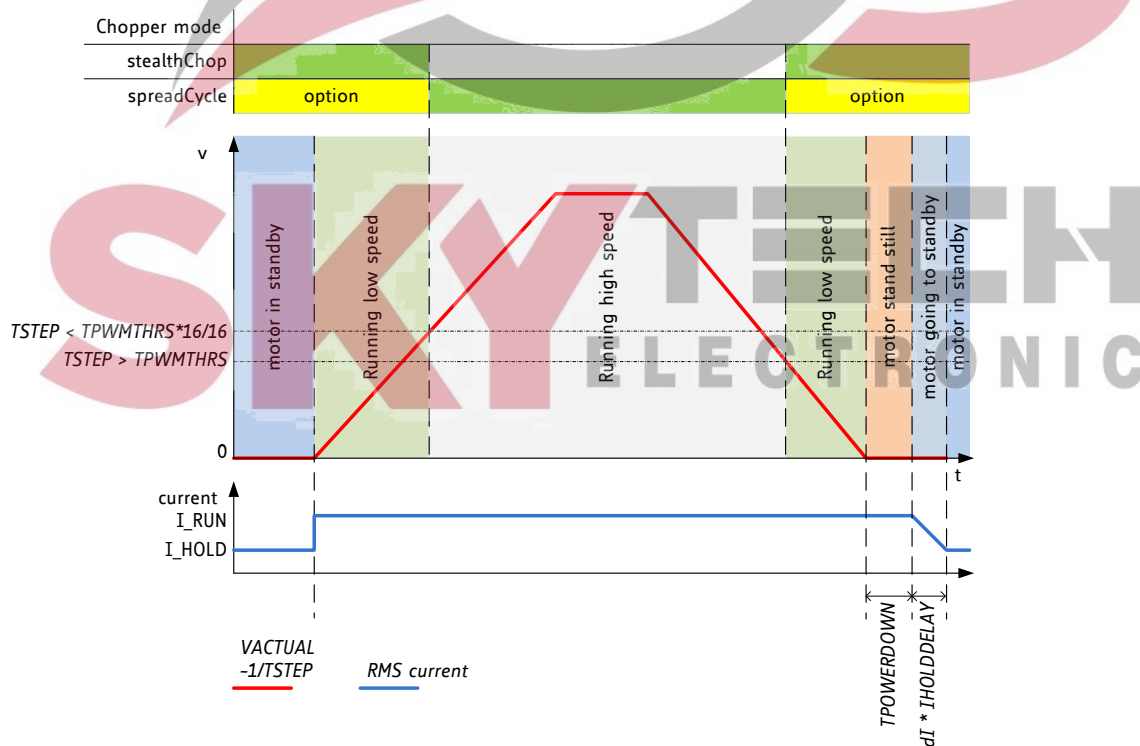

Figure 6.7 TPWMTHRS for optional switching to SpreadCycle

As a first step, both chopper principles should be parameterized and optimized individually (SpreadCycle settings may be programmed to OTP memory). In a next step, a transfer velocity has to be fixed. For example, StealthChop operation is used for precise low speed positioning, while SpreadCycle shall be used for highly dynamic motion. *TPWMTHRS* determines the transition velocity. Read out *TSTEP* when moving at the desired velocity and program the resulting value to *TPWMTHRS*. Use a low transfer velocity to avoid a jerk at the switching point.

A jerk occurs when switching at higher velocities, because the back-EMF of the motor (which rises with the velocity) causes a phase shift of up to 90° between motor voltage and motor current. So when switching at higher velocities between voltage PWM and current PWM mode, this jerk will occur with increased intensity. A high jerk may even produce a temporary overcurrent condition (depending on the motor coil resistance). At low velocities (e.g. 1 to a few 10 RPM), it can be completely neglected for most motors. Therefore, consider the switching jerk when choosing *TPWMTHRS*. Set *TPWMTHRS* zero if you want to work with StealthChop only.

When enabling the StealthChop mode the first time using automatic current regulation, the motor must be at stand still in order to allow a proper current regulation. When the drive switches to StealthChop at a higher velocity, StealthChop logic stores the last current regulation setting until the motor returns to a lower velocity again. This way, the regulation has a known starting point when returning to a lower velocity, where StealthChop becomes re-enabled. Therefore, neither the velocity threshold nor the supply voltage must be considerably changed during the phase while the chopper is switched to a different mode, because otherwise the motor might lose steps or the instantaneous current might be too high or too low.

A motor stall or a sudden change in the motor velocity may lead to the driver detecting a short circuit or to a state of automatic current regulation, from which it cannot recover. Clear the error flags and restart the motor from zero velocity to recover from this situation.

Hint

Start the motor from standstill when switching on StealthChop the first time and keep it stopped for at least 128 chopper periods to allow StealthChop to do initial standstill current control.

6.6 Flags in StealthChop



As StealthChop uses voltage mode driving, status flags based on current measurement respond slower, respectively the driver reacts delayed to sudden changes of back EMF, like on a motor stall.

Attention

A motor stall, or abrupt stop of the motion during operation in StealthChop can trigger an overcurrent condition. Depending on the previous motor velocity, and on the coil resistance of the motor, it significantly increases motor current for a time of several 10ms. With low velocities, where the back EMF is just a fraction of the supply voltage, there is no danger of triggering the short detection. When homing using StallGuard4 to stop the motor upon stall, this is basically avoided.

6.6.1 Open Load Flags

In StealthChop mode, status information is different from the cycle-by-cycle regulated SpreadCycle mode. OLA and OLB show if the current regulation sees that the nominal current can be reached on both coils.

- A flickering OLA or OLB can result from asymmetries in the sense resistors or in the motor coils.
- An interrupted motor coil leads to a continuously active open load flag for the coil.
- One or both flags are active, if the current regulation did not succeed in scaling up to the full target current within the last few fullsteps (because no motor is attached or a high velocity exceeds the PWM limit).

If desired, do an on-demand open load test using the SpreadCycle chopper, as it delivers the safest result. With StealthChop, *PWM_SCALE_SUM* can be checked to detect the correct coil resistance.

6.6.2 PWM_SCALE_SUM Informs about the Motor State

Information about the motor state is available with automatic scaling by reading out *PWM_SCALE_SUM*. As this parameter reflects the actual voltage required to drive the target current into the motor, it depends on several factors: motor load, coil resistance, supply voltage, and current setting. Therefore, an evaluation of the *PWM_SCALE_SUM* value allows checking the motor operation point. When reaching the limit (255), the current regulator cannot sustain the full motor current, e.g. due to a drop in supply voltage.



6.7 Freewheeling and Passive Braking

StealthChop provides different options for motor standstill. These options can be enabled by setting the standstill current *IHOLD* to zero and choosing the desired option using the *FREEWHEEL* setting. The desired option becomes enabled after a time period specified by *TPOWERDOWN* and *IHOLD_DELAY*. Current regulation becomes frozen once the motor target current is at zero current in order to ensure a quick startup. With the freewheeling options, both freewheeling and passive braking can be realized. Passive braking is an effective eddy current motor braking, which consumes a minimum of energy, because no active current is driven into the coils. However, passive braking will allow slow turning of the motor when a continuous torque is applied.

Hint

Operate the motor within your application when exploring StealthChop. Motor performance often is better with a mechanical load, because it prevents the motor from stalling due mechanical oscillations which can occur without load.

A large, stylized logo for SKYTECH ELECTRONIC. The word "SKY" is in a large, bold, pink font. The word "TECH" is in a smaller, bold, grey font. Below "TECH" is the word "ELECTRONIC" in a smaller, bold, grey font. The logo is set against a background of a large, stylized, grey and pink graphic that resembles a speech bubble or a stylized letter 'S'.

PARAMETERS RELATED TO STEALTHCHOP			
Parameter	Description	Setting	Comment
<i>en_spread_cycle</i>	General disable for use of StealthChop (register <i>GCONF</i>). The input <i>SPREAD</i> is XORed to this flag.	1	Do not use StealthChop
		0	StealthChop enabled
<i>TPWMTHRS</i>	Specifies the upper velocity for operation in StealthChop. Entry the <i>TSTEP</i> reading (time between two microsteps) when operating at the desired threshold velocity.	0 ... 1048575	StealthChop is disabled if <i>TSTEP</i> falls <i>TPWMTHRS</i>
<i>PWM_LIM</i>	Limiting value for limiting the current jerk when switching from SpreadCycle to StealthChop. Reduce the value to yield a lower current jerk.	0 ... 15	Upper four bits of 8 bit amplitude limit (Default=12)
<i>pwm_autoscale</i>	Enable automatic current scaling using current measurement or use forward controlled velocity based mode.	0	Forward controlled mode
		1	Automatic scaling with current regulator
<i>pwm_autograd</i>	Enable automatic tuning of <i>PWM_GRAD_AUTO</i>	0	disable, use <i>PWM_GRAD</i> from register instead
		1	enable
<i>PWM_FREQ</i>	PWM frequency selection. Use the lowest setting giving good results. The frequency measured at each of the chopper outputs is half of the effective chopper frequency f_{PWM} .	0	$f_{PWM}=2/1024 f_{CLK}$
		1	$f_{PWM}=2/683 f_{CLK}$
		2	$f_{PWM}=2/512 f_{CLK}$
		3	$f_{PWM}=2/410 f_{CLK}$
<i>PWM_REG</i>	User defined PWM amplitude (gradient) for velocity based scaling or regulation loop gradient when <i>pwm_autoscale</i> =1.	1 ... 15	Results in 0.5 to 7.5 steps for <i>PWM_SCALE_AUTO</i> regulator per fullstep
<i>PWM_OFS</i>	User defined PWM amplitude (offset) for velocity based scaling and initialization value for automatic tuning of <i>PWM_OFFS_AUTO</i> .	0 ... 255	<i>PWM_OFS</i> =0 disables linear current scaling based on current setting
<i>PWM_GRAD</i>	User defined PWM amplitude (gradient) for velocity based scaling and initialization value for automatic tuning of <i>PWM_GRAD_AUTO</i> .	0 ... 255	Reset value can be pre-programmed by OTP
<i>FREEWHEEL</i>	Stand still option when motor current setting is zero (<i>I_HOLD</i> =0). Only available with StealthChop enabled. The freewheeling option makes the motor easy movable, while both coil short options realize a passive brake.	0	Normal operation
		1	Freewheeling
		2	Coil short via LS drivers
		3	Coil short via HS drivers
<i>PWM_SCALE_AUTO</i>	Read back of the actual StealthChop voltage PWM scaling correction as determined by the current regulator. Should regulate to a value close to 0 during tuning procedure.	-255 ... 255	(read only) Scaling value becomes frozen when operating in SpreadCycle
<i>PWM_GRAD_AUTO</i> <i>PWM_OFFS_AUTO</i> <i>PWM_GRAD_AUTO</i>	Allow monitoring of the automatic tuning and determination of initial values for <i>PWM_OFFS</i> and <i>PWM_GRAD</i> .	0 ... 255	(read only)
<i>TOFF</i>	General enable for the motor driver, the actual value does not influence StealthChop	0	Driver off
		1 ... 15	Driver enabled
<i>TBL</i>	Comparator <i>blank time</i> . This time needs to safely cover the switching event and the duration of the ringing on the sense resistor. Choose a setting of 1 or 2 for typical applications. For higher capacitive loads, 3 may be required. Lower settings allow StealthChop to regulate down to lower coil current values.	0	16 t_{CLK}
		1	24 t_{CLK}
		2	32 t_{CLK}
		3	40 t_{CLK}

7 SpreadCycle Chopper

While StealthChop is a voltage mode PWM controlled chopper, SpreadCycle is a cycle-by-cycle current control. Therefore, it can react extremely fast to changes in motor velocity or motor load. SpreadCycle will give better performance in medium to high velocity range for motors and applications which tend to resonance. The currents through both motor coils are controlled using choppers. The choppers work independently of each other. In Figure 7.1 the different chopper phases are shown.

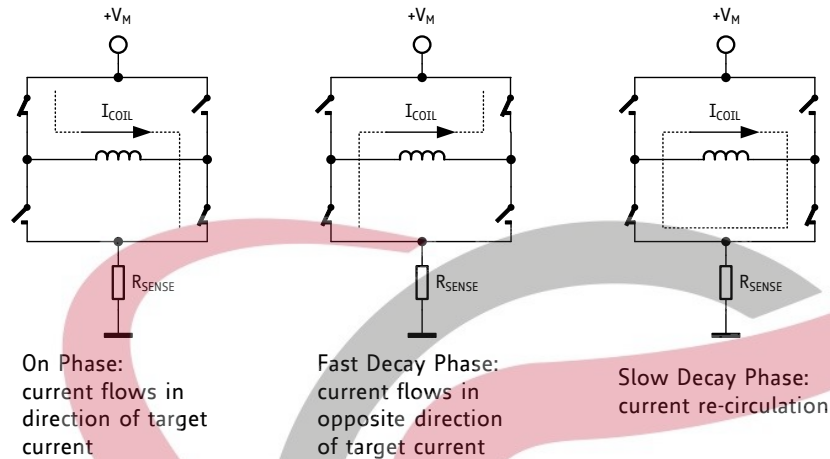

Figure 7.1 Chopper phases

Although the current could be regulated using only on phases and fast decay phases, insertion of the slow decay phase is important to reduce electrical losses and current ripple in the motor. The duration of the slow decay phase is specified in a control parameter and sets an upper limit on the chopper frequency. The current comparator can measure coil current during phases when the current flows through the sense resistor, but not during the slow decay phase, so the slow decay phase is terminated by a timer. The on phase is terminated by the comparator when the current through the coil reaches the target current. The fast decay phase may be terminated by either the comparator or another timer.

When the coil current is switched, spikes at the sense resistors occur due to charging and discharging parasitic capacitances. During this time, typically one or two microseconds, the current cannot be measured. Blanking is the time when the input to the comparator is masked to block these spikes.

The SpreadCycle chopper mode cycles through four phases: on, slow decay, fast decay, and a second slow decay.

The chopper frequency is an important parameter for a chopped motor driver. A too low frequency might generate audible noise. A higher frequency reduces current ripple in the motor, but with a too high frequency magnetic losses may rise. Also power dissipation in the driver rises with increasing frequency due to the increased influence of switching slopes causing dynamic dissipation. Therefore, a compromise needs to be found. Most motors are optimally working in a frequency range of 16 kHz to 30 kHz. The chopper frequency is influenced by a number of parameter settings as well as by the motor inductivity and supply voltage.

Hint

A chopper frequency in the range of 16 kHz to 30 kHz gives a good result for most motors when using SpreadCycle. A higher frequency leads to increased switching losses.



7.1 SpreadCycle Settings

The SpreadCycle (patented) chopper algorithm is a precise and simple to use chopper mode which automatically determines the optimum length for the fast-decay phase. The SpreadCycle will provide superior microstepping quality even with default settings. Several parameters are available to optimize the chopper to the application.

Each chopper cycle is comprised of an on phase, a slow decay phase, a fast decay phase and a second slow decay phase (see Figure 7.3). The two slow decay phases and the two blank times per chopper cycle put an upper limit to the chopper frequency. The slow decay phases typically make up for about 30%-70% of the chopper cycle in standstill and are important for low motor and driver power dissipation.

Calculation of a starting value for the slow decay time $TOFF$:

EXAMPLE:

Target Chopper frequency: 25kHz.

Assumption: Two slow decay cycles make up for 50% of overall chopper cycle time

$$t_{OFF} = \frac{1}{25kHz} * \frac{50}{100} * \frac{1}{2} = 10\mu s$$

For the $TOFF$ setting this means:

$$TOFF = (t_{OFF} * f_{CLK} - 24)/32$$

With 12 MHz clock this gives a setting of $TOFF=3.0$, i.e. 3.

With 16 MHz clock this gives a setting of $TOFF=4.25$, i.e. 4 or 5.

The hysteresis start setting forces the driver to introduce a minimum amount of current ripple into the motor coils. The current ripple must be higher than the current ripple which is caused by resistive losses in the motor in order to give best microstepping results. This will allow the chopper to precisely regulate the current both for rising and for falling target current. The time required to introduce the current ripple into the motor coil also reduces the chopper frequency. Therefore, a higher hysteresis setting will lead to a lower chopper frequency. The motor inductance limits the ability of the chopper to follow a changing motor current. Further the duration of the on phase and the fast decay must be longer than the blanking time, because the current comparator is disabled during blanking.

It is easiest to find the best setting by starting from a low hysteresis setting (e.g. $HSTRT=0$, $HEND=0$) and increasing $HSTRT$, until the motor runs smoothly at low velocity settings. This can best be checked when measuring the motor current either with a current probe or by probing the sense resistor voltages (see Figure 7.2). Checking the sine wave shape near zero transition will show a small ledge between both half waves in case the hysteresis setting is too small. At medium velocities (i.e. 100 to 400 fullsteps per second), a too low hysteresis setting will lead to increased humming and vibration of the motor.

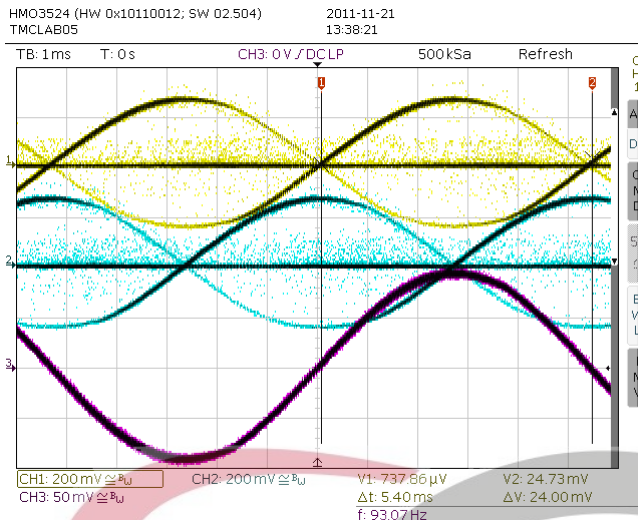

Figure 7.2 No ledges in current wave with sufficient hysteresis (magenta: current A, yellow & blue: sense resistor voltages A and B)

A too high hysteresis setting will lead to reduced chopper frequency and increased chopper noise but will not yield any benefit for the wave shape.

Quick Start

For a quick start, see the Quick Configuration Guide in chapter 16.

For detail procedure see Application Note AN001 - *Parameterization of SpreadCycle*

As experiments show, the setting is quite independent of the motor, because higher current motors typically also have a lower coil resistance. Therefore, choosing a low to medium default value for the hysteresis (for example, effective hysteresis = 4) normally fits most applications. The setting can be optimized by experimenting with the motor: A too low setting will result in reduced microstep accuracy, while a too high setting will lead to more chopper noise and motor power dissipation. When measuring the sense resistor voltage in motor standstill at a medium coil current with an oscilloscope, a too low setting shows a fast decay phase not longer than the blanking time. When the fast decay time becomes slightly longer than the blanking time, the setting is optimum. You can reduce the off-time setting, if this is hard to reach.

The hysteresis principle could in some cases lead to the chopper frequency becoming too low, e.g. when the coil resistance is high when compared to the supply voltage. This is avoided by splitting the hysteresis setting into a start setting (*HSTRT+HEND*) and an end setting (*HEND*). An automatic hysteresis decremter (*HDEC*) interpolates between both settings, by decremting the hysteresis value stepwise each 16 system clocks. At the beginning of each chopper cycle, the hysteresis begins with a value which is the sum of the start and the end values (*HSTRT+HEND*), and decremms during the cycle, until either the chopper cycle ends or the hysteresis end value (*HEND*) is reached. This way, the chopper frequency is stabilized at high amplitudes and low supply voltage situations, if the frequency gets too low. This avoids the frequency reaching the audible range.

Hint

Highest motor velocities sometimes benefit from setting *TOFF* to 1 or 2 and a short *TBL* of 1 or 0.

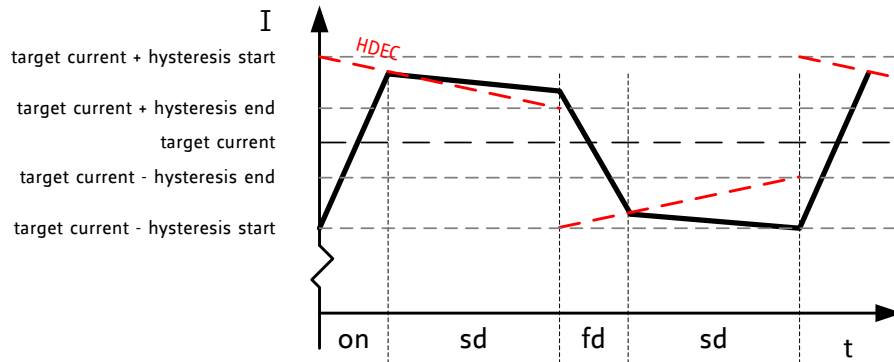

Figure 7.3 SpreadCycle chopper scheme showing coil current during a chopper cycle

These parameters control SpreadCycle mode:

Parameter	Description	Setting	Comment
<i>TOFF</i>	Sets the slow decay time (<i>off time</i>). This setting also limits the maximum chopper frequency. For operation with StealthChop, this parameter is not used, but it is required to enable the motor. In case of operation with StealthChop only, any setting is OK. Setting this parameter to zero completely disables all driver transistors and the motor can free-wheel.	0	chopper off
		1...15	off time setting $N_{CLK} = 24 + 32 \cdot TOFF$ (1 will work with minimum blank time of 24 clocks)
<i>TBL</i>	Comparator <i>blank time</i> . This time needs to safely cover the switching event and the duration of the ringing on the sense resistor. For most applications, a setting of 1 or 2 is good. For highly capacitive loads, a setting of 2 or 3 will be required.	0	16 t_{CLK}
		1	24 t_{CLK}
		2	32 t_{CLK}
		3	40 t_{CLK}
<i>HSTRT</i>	<i>Hysteresis start</i> setting. This value is an offset from the hysteresis end value <i>HEND</i> .	0...7	$HSTRT=1...8$ This value adds to HEND.
<i>HEND</i>	<i>Hysteresis end</i> setting. Sets the hysteresis end value after a number of decrements. The sum $HSTRT+HEND$ must be ≤ 16 . At a current setting of max. 30 (amplitude reduced to 240), the sum is not limited.	0...2	-3...-1: negative HEND
		3	0: zero HEND
		4...15	1...12: positive HEND

Even at $HSTRT=0$ and $HEND=0$, the TMC2209 sets a minimum hysteresis via analog circuitry.

EXAMPLE:

A hysteresis of 4 has been chosen. You might decide to not use hysteresis decrement. In this case set:

$HEND=6$ (sets an effective end value of $6-3=3$)
 $HSTRT=0$ (sets minimum hysteresis, i.e. $1: 3+1=4$)

In order to take advantage of the variable hysteresis, we can set most of the value to the *HSTRT*, i.e. 4, and the remaining 1 to hysteresis end. The resulting configuration register values are as follows:

$HEND=0$ (sets an effective end value of -3)
 $HSTRT=6$ (sets an effective start value of hysteresis end +7: $7-3=4$)

8 Selecting Sense Resistors

Set the desired maximum motor current by selecting an appropriate value for the sense resistor. The following table shows the RMS current values which can be reached using standard resistors and motor types fitting without additional motor current scaling.

CHOICE OF R_{SENSE} AND RESULTING MAX. MOTOR CURRENT		
R_{SENSE} [Ω]	RMS current [A] VREF=2.5V (or open), IRUN=31, vsense=0 (standard)	Fitting motor type (examples)
1.00	0.23	300mA motor
0.82	0.27	
0.75	0.30	
0.68	0.33	
0.50	0.44	400mA motor
470m	0.47	500mA motor
390m	0.56	600mA motor
330m	0.66	700mA motor
270m	0.79	800mA motor
220m	0.96	1A motor
180m	1.15	1.2A motor
150m	1.35	1.5A motor
120m	1.64	1.7A motor
100m	1.92	2A motor
75m	2.4*)	

*) Value exceeds upper current rating, scaling down required, e.g. by reduced VREF.

Sense resistors should be carefully selected. The full motor current flows through the sense resistors. Due to chopper operation the sense resistors see pulsed current from the MOSFET bridges. Therefore, a low-inductance type such as film or composition resistors is required to prevent voltage spikes causing ringing on the sense voltage inputs leading to unstable measurement results. Also, a low-inductance, low-resistance PCB layout is essential. Any common GND path for the two sense resistors must be avoided, because this would lead to coupling between the two current sense signals. A massive ground plane is best. Please also refer to layout considerations in chapter 21.

The sense resistor needs to be able to conduct the peak motor coil current in motor standstill conditions, unless standby power is reduced. Under normal conditions, the sense resistor conducts less than the coil RMS current, because no current flows through the sense resistor during the slow decay phases. A 0.5W type is sufficient for most applications up to 1.2A RMS current.

Attention

Be sure to use a symmetrical sense resistor layout and short and straight sense resistor traces of identical length. Well matching sense resistors ensure best performance.

A compact layout with massive ground plane is best to avoid parasitic resistance effects.

Check the resulting motor current in a practical application and with the desired motor.

9 Motor Current Control

The basic motor current is set by the resistance of the sense resistors. Several possibilities allow scaling down motor current, e.g. to adapt for different motors, or to reduce motor current in standstill or low load situations.

METHODS FOR SCALING MOTOR CURRENT			
Method	Parameters	Range	Primary Use
Pin VREF voltage (chapter 9.1)	VREF input scales <i>IRUN</i> and <i>IHOLD</i> . Can be disabled by <i>GCONF.i_scale_analog</i>	2.5V: 100% ... 0.5V: 20% >2.5V or open: 100% <0.5V: not recommended	<ul style="list-style-type: none"> - Fine tuning of motor current to fit the motor type - Manual tuning via poti - Delayed or soft power-up - Standstill current reduction (preferred only with SpreadCycle)
Pin ENN	Disable / enable driver stage	0: Motor enable 1: Motor disable	<ul style="list-style-type: none"> - Disable motor to allow freewheeling
Pin PDN_UART	Disable / enable standstill current reduction to <i>IHOLD</i>	0: Standstill current reduction enabled. 1: Disable	<ul style="list-style-type: none"> - Enable current reduction to reduce heat up in stand still
OTP memory	<i>OTP_IHOLD</i> , <i>OTP_IHOLDDELAY</i>	9% to 78% standby current. Reduction in about 300ms to 2.5s	<ul style="list-style-type: none"> - Program current reduction to fit application for highest efficiency and lowest heat up
OTP memory	<i>otp_internalRsense</i>	0: Use sense resistors 1: Internal resistors	<ul style="list-style-type: none"> - Save two sense resistors on BOM, set current by single inexpensive 0603 resistor.
UART interface	<i>IHOLD_IRUN</i> <i>TPOWERDOWN</i> <i>OTP</i>	<i>IRUN</i> , <i>IHOLD</i> : 1/32 to 32/32 of full scale current.	<ul style="list-style-type: none"> - Fine programming of run and hold (stand still) current - Change <i>IRUN</i> for situation specific motor current - Set OTP options
UART interface	<i>CHOPCONF.vsense</i> flag	0: Normal, most robust 1: Reduced voltage level	<ul style="list-style-type: none"> - Set <i>vsense</i> for half power dissipation in sense resistor to use smaller 0.25W resistors.

Select the sense resistor to deliver enough current for the motor at full current scale ($V_{REF}=2.5V$). This is the default current scaling ($IRUN = 31$).

STANDALONE MODE RMS RUN CURRENT CALCULATION:

$$I_{RMS} = \frac{325mV}{R_{SENSE} + 20m\Omega} * \frac{1}{\sqrt{2}} * \frac{V_{VREF}}{2.5V}$$

IRUN and *IHOLD* allow for scaling of the actual current scale (CS) from 1/32 to 32/32 when using UART interface, or via automatic standstill current reduction:

RMS CURRENT CALCULATION WITH UART CONTROL OPTIONS OR HOLD CURRENT SETTING:

$$I_{RMS} = \frac{CS + 1}{32} * \frac{V_{FS}}{R_{SENSE} + 20m\Omega} * \frac{1}{\sqrt{2}}$$

CS is the current scale setting as set by the *IHOLD* and *IRUN*.

V_{FS} is the full scale voltage as determined by *vsense* control bit (please refer to electrical characteristics, V_{SRTL} and V_{SRTH}). Default is 325mV.

With analog scaling of V_{FS} (*I_scale_analog*=1, default), the resulting voltage V_{FS}' is calculated by:

$$V'_{FS} = V_{FS} * \frac{V_{VREF}}{2.5V}$$

with V_{VREF} the voltage on pin VREF in the range 0V to $V_{5VOUT}/2$

Hint

For best precision of current setting, measure and fine tune the current in the application.

PARAMETERS FOR MOTOR CURRENT CONTROL			
Parameter	Description	Setting	Comment
<i>IRUN</i>	Current scale when motor is running. Scales coil current values as taken from the internal sine wave table. For high precision motor operation, work with a current scaling factor in the range 16 to 31, because scaling down the current values reduces the effective microstep resolution by making microsteps coarser.	0 ... 31	scaling factor 1/32, 2/32, ... 32/32 <i>IRUN</i> is full scale (setting 31) in standalone mode.
<i>IHOLD</i>	Identical to <i>IRUN</i> , but for motor in stand still.		
<i>IHOLD DELAY</i>	Allows smooth current reduction from run current to hold current. <i>IHOLDDELAY</i> controls the number of clock cycles for motor power down after <i>TPOWERDOWN</i> in increments of 2^{18} clocks: 0=instant power down, 1..15: Current reduction delay per current step in multiple of 2^{18} clocks. <i>Example:</i> When using <i>IRUN</i> =31 and <i>IHOLD</i> =16, 15 current steps are required for hold current reduction. A <i>IHOLDDELAY</i> setting of 4 thus results in a power down time of $4*15*2^{18}$ clock cycles, i.e. roughly one second at 16MHz clock frequency.	0 1 ... 15	instant <i>IHOLD</i> $1*2^{18} \dots 15*2^{18}$ clocks per current decrement
<i>TPOWER DOWN</i>	Sets the delay time from stand still (<i>stst</i>) detection to motor current power down. Time range is about 0 to 5.6 seconds.	0 ... 255	$0 \dots ((2^8)-1) * 2^{18} t_{CLK}$ A minimum setting of 2 is required to allow automatic tuning of <i>PWM_OFFS_AUTO</i>
<i>vsense</i>	Allows control of the sense resistor <i>voltage range</i> for full scale current. The low voltage range allows a reduction of sense resistor power dissipation.	0 1	$V_{FS} = 0.32 V$ $V_{FS} = 0.18 V$

9.1 Analog Current Scaling VREF ELECTRONIC

When a high flexibility of the output current scaling is desired, the analog input of the driver can be used for current control, rather than choosing a different set of sense resistors or scaling down the run current via the interface using *IRUN* or *IHOLD* parameters. This way, a simple voltage divider adapts a board to different motors.

VREF SCALES THE MOTOR CURRENT

The TMC2209 provides an internal reference voltage for current control, directly derived from the 5VOUT supply output. Alternatively, an external reference voltage can be used. This reference voltage becomes scaled down for the chopper comparators. The chopper comparators compare the voltages on BRA and BRB to the scaled reference voltage for current regulation. When *I_scale_analog* in *GCONF* is enabled (default), the external voltage on VREF is amplified and filtered and becomes used as reference voltage. A voltage of 2.5V (or any voltage between 2.5V and 5V) gives the same current

scaling as the internal reference voltage. A voltage between 0V and 2.5V linearly scales the current between 0 and the current scaling defined by the sense resistor setting. It is not advised to work with reference voltages below about 0.5V to 1V for full scale, because relative analog noise caused by digital circuitry and power supply ripple has an increased impact on the chopper precision at low VREF voltages. For best precision, choose the sense resistors in a way that the desired maximum current is reached with VREF in the range 2V to 2.4V. Be sure to optimize the chopper settings for the normal run current of the motor.

DRIVING VREF

The easiest way to provide a voltage to VREF is to use a voltage divider from a stable supply voltage or a microcontroller's DAC output. A PWM signal also allows current control. The PWM becomes transformed to an analog voltage using an additional R/C low-pass at the VREF pin. The PWM duty cycle controls the analog voltage. Choose the R and C values to form a low pass with a corner frequency of several milliseconds while using PWM frequencies well above 10 kHz. VREF additionally provides an internal low-pass filter with 3.5kHz bandwidth.

Hint

Using a low reference voltage (e.g. below 1V), for adaptation of a high current driver to a low current motor will lead to reduced analog performance. Adapt the sense resistors to fit the desired motor current for the best result.

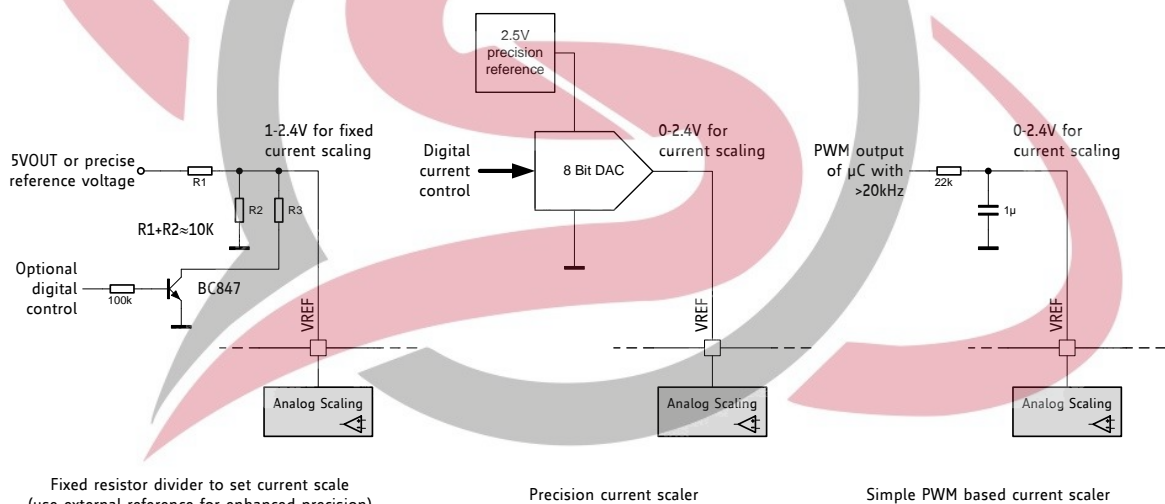

Figure 9.1 Scaling the motor current using the analog input



10 Internal Sense Resistors

The TMC2209 provides the option to eliminate external sense resistors. In this mode the external sense resistors become omitted (shorted) and the internal on-resistance of the power MOSFETs is used for current measurement (see chapter 3.2). As MOSFETs are both, temperature dependent and subject to production stray, a tiny external resistor connected from +5VOUT to VREF provides a precise absolute current reference. This resistor converts the 5V voltage into a reference current. Be sure to directly attach BRA and BRB pins to GND in this mode near the IC package. The mode is enabled by setting *internal_Rsense* in *GCONF* (OTP option).

COMPARING INTERNAL SENSE RESISTORS VS. SENSE RESISTORS		
Item	Internal Sense Resistors	External Sense Resistors
Ease of use	Need to set OTP parameter before motor enable	(+) Default
Cost	(+) Save cost for sense resistors	
Current precision	Slightly reduced	(+) Good
Current Range Recommended	200mA RMS to 1.4A RMS	50mA to 2A RMS
Recommended chopper	StealthChop or SpreadCycle SpreadCycle shows slightly more distortion at >1.4A RMS	StealthChop or SpreadCycle

While the R_{DSon} based measurements bring benefits concerning cost and size of the driver, it gives slightly less precise coil current regulation when compared to external sense resistors. The internal sense resistors have a certain temperature dependence, which is automatically compensated by the driver IC. However, for high current motors, a temperature gradient between the ICs internal sense resistors and the compensation circuit will lead to an initial current overshoot of some 10% during driver IC heat up. While this phenomenon shows for roughly a second, it might even be beneficial to enable increased torque during initial motor acceleration.

PRINCIPLE OF OPERATION

A reference current into the VREF pin is used as reference for the motor current. In order to realize a certain current, a single resistor (R_{REF}) can be connected between 5VOUT and VREF (pls. refer the table for the choice of the resistor). VREF input resistance is about 0.45kOhm. The resulting current into VREF is amplified 3000 times. Thus, a current of 0.33mA yields a motor current of 1.0A peak, or 0.7A RMS. For calculation of the reference resistor, the internal resistance of VREF needs to be considered additionally.

CHOICE OF R_{REF} FOR OPERATION WITHOUT SENSE RESISTORS		
R_{REF} [Ω]	Peak current [A] (CS=31, vsense=0)	RMS current [A] (CS=31, vsense=0)
6k2	2.26	1.59
6k8	1.92	1.35
7k5	1.76	1.24
8k2	1.63	1.15
9k1	1.49	1.05
10k	1.36	0.96
12k	1.15	0.81
15k	0.94	0.66
18k	0.79	0.55
22k	0.65	0.45
27k	0.60	0.42
33k	0.54	0.38

$vsense=1$ allows a lower peak current setting of about 55% of the value yielded with $vsense=0$ (as specified by V_{SRTH} / V_{SRTL}).

In RDSon measurement mode, connect the BRA and BRB pins to GND using the shortest possible path (i.e. shortest possible PCB path). RDSon based measurement gives best results when combined with StealthChop. When using SpreadCycle with RDSon based current measurement, slightly asymmetric current measurement for positive currents (on phase) and negative currents (fast decay phase) may result in chopper noise. This especially occurs at high die temperature and increased motor current.

Note

The absolute current levels achieved with RDSon based current sensing may depend on PCB layout exactly like with external sense resistors, because trace resistance on BR pins will add to the effective sense resistance. Therefore, we recommend to measure and calibrate the current setting within the application.

Thumb rule

RDSon based current sensing works best for motors with up to 1.4A RMS current. The best results are yielded with StealthChop operation in combination with RDSon based current sensing. For most precise current control and for best results with SpreadCycle, it is recommended to use external 1% sense resistors rather than RDSon based current control.



The logo for SKYTECH ELECTRONIC features a large, stylized 'S' in the background, composed of red and grey curved lines. Below the 'S', the word 'SKYTECH' is written in a bold, sans-serif font, with 'SKY' in red and 'TECH' in grey. Underneath 'SKYTECH', the word 'ELECTRONIC' is written in a smaller, grey, sans-serif font.



11 StallGuard4 Load Measurement

StallGuard4 provides an accurate measurement of the load on the motor. It is developed for operation in conjunction with StealthChop. StallGuard can be used for stall detection as well as other uses at loads below those which stall the motor, such as CoolStep load-adaptive current reduction. The StallGuard4 measurement value changes linearly over a wide range of load, velocity, and current settings, as shown in Figure 11.1. When approaching maximum motor load, the value goes down to a motor-specific lower value. This corresponds to a load angle of 90° between the magnetic field of the coils and magnets in the rotor. This also is the most energy-efficient point of operation for the motor.

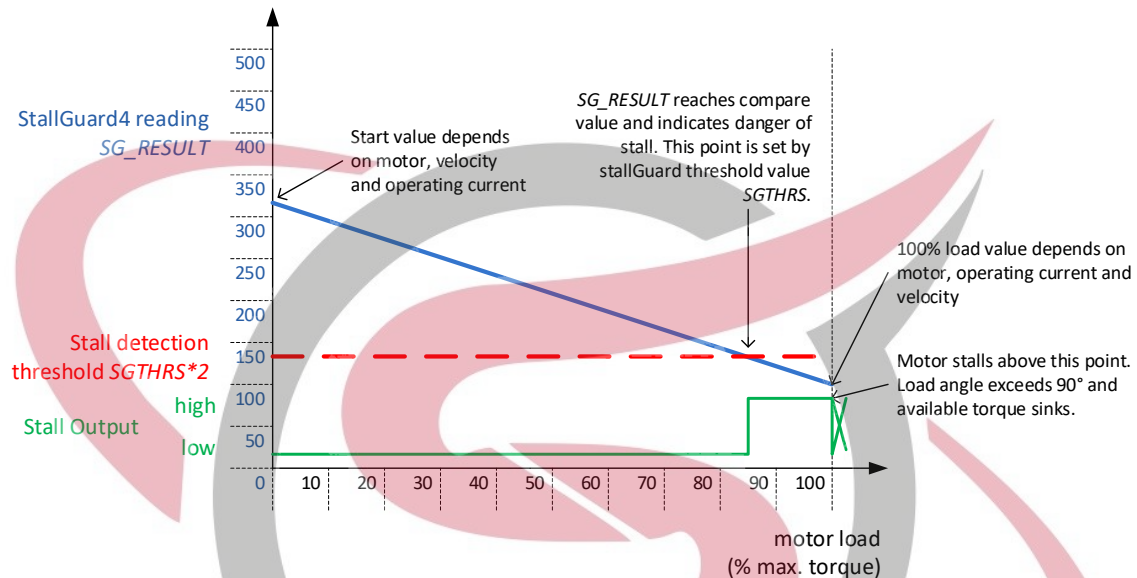

Figure 11.1 Function principle of StallGuard4

Parameter	Description	Setting	Comment
<i>SGTHRS</i>	This value controls the StallGuard4 threshold level for stall detection. It compensates for motor specific characteristics and controls sensitivity. A higher value gives a higher sensitivity. A higher value makes StallGuard4 more sensitive and requires less torque to indicate a stall.	0... 255	The double of this value is compared to <i>SG_RESULT</i> . The stall output becomes active if <i>SG_RESULT</i> fall below this value.
Status word	Description	Range	Comment
<i>SG_RESULT</i>	This is the <i>StallGuard4 result</i> . A higher reading indicates less mechanical load. A lower reading indicates a higher load and thus a higher load angle.	0... 510	Low value: highest load High value: high load

In order to use StallGuard4, check the sensitivity of the motor at border conditions.

11.1 StallGuard4 vs. StallGuard2

StallGuard4 is optimized for operation with StealthChop, its predecessor StallGuard2 works with SpreadCycle. The function is similar: Both deliver a load value, going from a high value at low load, to a low value at high load. While StallGuard2 becomes tuned to show a "0"-reading for stall detection, StallGuard4 uses a comparison-value to trigger stall detection, rather than shifting *SG_RESULT* itself.

11.2 Tuning StallGuard4

The StallGuard4 value *SG_RESULT* is affected by motor-specific characteristics and application-specific demands on load, coil current, and velocity. Therefore, the easiest way to tune the StallGuard4 threshold *SGTHRS* for a specific motor type and operating conditions is interactive tuning in the actual application.

INITIAL PROCEDURE FOR TUNING STALLGUARD *SGTHRS*

1. Operate the motor at the normal operation velocity for your application and monitor *SG_RESULT*.
2. Apply slowly increasing mechanical load to the motor. Check the lowest value of *SG_RESULT* before the motor stalls. Use this value as starting value for *SGTHRS* (apply half of the value).
3. Now monitor the StallGuard output signal via DIAG output (configure properly, also set *TCOOLTHRS* to match the lower velocity limit for operation) and stop the motor when a pulse is seen on the respective output. Make sure, that the motor is safely stopped whenever it is stalled. Increase *SGTHRS* if the motor becomes stopped before a stall occurs.
4. The optimum setting is reached when a stall is safely detected and leads to a pulse at DIAG in the moment where the stall occurs. *SGTHRS* in most cases can be tuned for a certain motion velocity or a velocity range. Make sure, that the setting works reliable in a certain range (e.g. 80% to 120% of desired velocity) and also under extreme motor conditions (lowest and highest applicable temperature).

DIAG is pulsed by StallGuard, when *SG_RESULT* falls below *SGTHRS*. It is only enabled in StealthChop mode, and when $TCOOLTHRS \geq TSTEP > TPWMTHRS$. The external motion controller should react to a single pulse by stopping the motor if desired. Set *TCOOLTHRS* to match the lower velocity threshold where StallGuard delivers a good result.

SG_RESULT measurement has a high resolution, and there are a few ways to enhance its accuracy, as described in the following sections.

11.3 StallGuard4 Update Rate

The StallGuard4 measurement value *SG_RESULT* is updated with each full step of the motor. This is enough to safely detect a stall, because a stall always means the loss of four full steps.

11.4 Detecting a Motor Stall

To safely detect a motor stall, the stall threshold must be determined using a specific *SGTHRS* setting and a specific motor velocity or velocity range. Further, the motor current setting has a certain influence and should not be modified, once optimum values are determined. Therefore, the maximum load needs to be determined the motor can drive without stalling. At the same time, monitor *SG_RESULT* at this load. The stall threshold should be a value safely within the operating limits, to allow for parameter stray. More refined evaluation may also react to a change of *SG_RESULT* rather than comparing to a fixed threshold. This will rule out certain effects which influence the absolute value.

11.5 Limits of StallGuard4 Operation

StallGuard4 does not operate reliably at extreme motor velocities: Very low motor velocities (for many motors, less than one revolution per second) generate a low back EMF and make the measurement unstable and dependent on environment conditions (temperature, etc.). Other conditions will also lead to a poor response of the measurement value *SG_RESULT* to the motor load. Very high motor velocities, in which the full sinusoidal current is not driven into the motor coils also leads to poor response. These velocities are typically characterized by the motor back EMF exceeding the supply voltage.

12 CoolStep Operation



CoolStep is an automatic smart energy optimization for stepper motors based on the motor mechanical load, making them "green".

12.1 User Benefits



- Energy efficiency* - consumption decreased up to 75%
- Motor generates less heat* - improved mechanical precision
- Less cooling infrastructure* - for motor and driver
- Cheaper motor* - does the job!

CoolStep allows substantial energy savings, especially for motors which see varying loads or operate at a high duty cycle. Because a stepper motor application needs to work with a torque reserve of 30% to 50%, even a constant-load application allows significant energy savings because CoolStep automatically enables torque reserve when required. Reducing power consumption keeps the system cooler, increases motor life, and allows reducing cost in the power supply and cooling components.

Reducing motor current by half results in reducing power by a factor of four.

12.2 Setting up for CoolStep

CoolStep is controlled by several parameters, but two are critical for understanding how it works:

Parameter	Description	Range	Comment
<i>SEMIN</i>	4-bit unsigned integer that sets a <i>lower threshold</i> . If <i>SG_RESULT</i> goes below this threshold, CoolStep increases the current to both coils. The 4-bit <i>SEMIN</i> value is scaled by 32 to cover the lower half of the range of the 10-bit <i>SG</i> value. (The name of this parameter is derived from SmartEnergy, which is an earlier name for CoolStep.)	0 1...15	disable CoolStep threshold is $SEMIN * 32$ Once <i>SGTHRS</i> has been determined, use $1/16 * SGTHRS + 1$ as a starting point for <i>SEMIN</i> .
<i>SEMAX</i>	4-bit unsigned integer that controls an <i>upper threshold</i> . If <i>SG</i> is sampled equal to or above this threshold enough times, CoolStep decreases the current to both coils. The upper threshold is $(SEMIN + SEMAX + 1) * 32$.	0...15	threshold is $(SEMIN + SEMAX + 1) * 32$ 0 to 2 recommended

Figure 12.1 shows the operating regions of CoolStep:

- The black line represents the *SG_RESULT* measurement value.
- The blue line represents the mechanical load applied to the motor.
- The red line represents the current into the motor coils.

When the load increases, *SG_RESULT* falls below *SEMIN*, and CoolStep increases the current. When the load decreases, *SG_RESULT* rises above $(SEMIN + SEMAX + 1) * 32$, and the current is reduced.

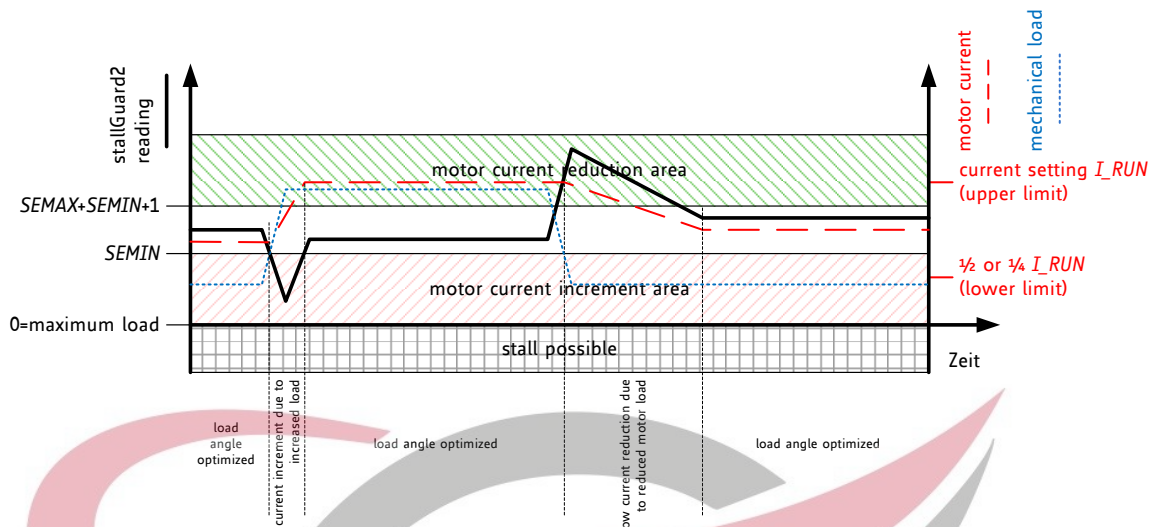

Figure 12.1 CoolStep adapts motor current to the load

Five more parameters control CoolStep and one status value is returned:

Parameter	Description	Range	Comment
SEUP	Sets the <i>current increment step</i> . The current becomes incremented for each measured StallGuard2 value below the lower threshold.	0...3	step width is 1, 2, 4, 8
SEDN	Sets the number of StallGuard2 readings above the upper threshold necessary for each <i>current decrement</i> of the motor current.	0...3	number of StallGuard2 measurements per decrement: 32, 8, 2, 1
SEIMIN	Sets the <i>lower motor current limit</i> for CoolStep operation by scaling the <i>IRUN</i> current setting. Operate well above the minimum motor current as determined for StealthChop current regulation.	0 1	0: 1/2 of IRUN 1: 1/4 of IRUN
TCOOLTHRS	Lower velocity threshold for switching on CoolStep and stall output. Below this velocity CoolStep becomes disabled (not used in STEP/DIR mode). Adapt to the lower limit of the velocity range where StallGuard2 gives a stable result.	1... 2 ²⁰ -1	Specifies lower CoolStep velocity by comparing the threshold value to <i>TSTEP</i>
TPWMTHRS	Upper velocity threshold value for CoolStep and stop on stall. Above this velocity the driver switches to SpreadCycle. This also disables CoolStep and StallGuard.	1... 2 ²⁰ -1	This setting typically is used during chopper mode configuration, only.
Status word	Description	Range	Comment
CSACTUAL	This status value provides the <i>actual motor current scale</i> as controlled by CoolStep. The value goes up to the <i>IRUN</i> value and down to the portion of <i>IRUN</i> as specified by <i>SEIMIN</i> .	0...31	1/32, 2/32, ... 32/32

12.3 Tuning CoolStep

CoolStep uses *SG_RESULT* to operate the motor near the optimum load angle of +90°. The basic setting to be tuned is *SEMIN*. Set *SEMIN* to a value which safely activates CoolStep current increment before the motor stalls. In case *SGTHRS* has been tuned before, a lower starting value is

$$SEMIN = 1 + SGTHRS / 16.$$

The current increment speed is specified in *SEUP*, and the current decrement speed is specified in *SEDN*. They can be tuned separately because they are triggered by different events that may need different responses. The encodings for these parameters allow the coil currents to be increased much more quickly than decreased, because crossing the lower threshold is a more serious event that may require a faster response. If the response is too slow, the motor may stall. In contrast, a slow response to crossing the upper threshold does not risk anything more serious than missing an opportunity to save power.

CoolStep operates between limits controlled by the current scale parameter *IRUN* and the *seimin* bit.

Attention

When CoolStep increases motor current, spurious detection of motor stall may occur. For best results, disable CoolStep during StallGuard based homing. In case StallGuard is desired in combination with CoolStep, try increasing coolStep lower threshold *SEMIN* as required.

12.3.1 Response Time

For fast response to increasing motor load, use a high current increment step *SEUP*. If the motor load changes slowly, a lower current increment step can be used to avoid motor oscillations.

Hint

The most common and most beneficial use is to adapt CoolStep for operation at the typical system target operation velocity and to set the velocity thresholds according. As acceleration and decelerations normally shall be quick, they will require the full motor current, while they have only a small contribution to overall power consumption due to their short duration.

12.3.2 Low Velocity and Standby Operation

Because CoolStep is not able to measure the motor load in standstill and at very low RPM, a lower velocity threshold is provided for enabling CoolStep. It should be set to an application specific default value. Below this threshold the normal current setting via *IRUN* respectively *IHOLD* is valid.

13 STEP/DIR Interface

The STEP and DIR inputs provide a simple, standard interface compatible with many existing motion controllers. The MicroPlyer step pulse interpolator brings the smooth motor operation of high-resolution microstepping to applications originally designed for coarser stepping.

13.1 Timing

Figure 13.1 shows the timing parameters for the STEP and DIR signals, and the table below gives their specifications. Only rising edges are active. STEP and DIR are sampled and synchronized to the system clock. An internal analog filter removes glitches on the signals, such as those caused by long PCB traces. If the signal source is far from the chip, and especially if the signals are carried on cables, the signals should be filtered or differentially transmitted.

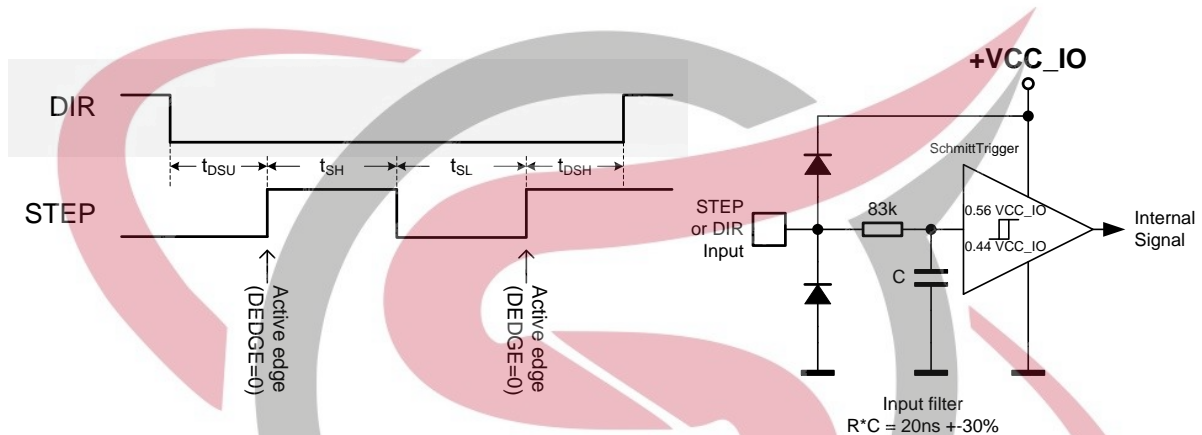

Figure 13.1 STEP and DIR timing, Input pin filter

STEP and DIR interface timing		AC-Characteristics clock period is t_{CLK}				
Parameter	Symbol	Conditions	Min	Typ	Max	Unit
step frequency (at maximum microstep resolution)	f_{STEP}				$\frac{1}{2} f_{CLK}$	
fullstep frequency	f_{FS}				$f_{CLK}/512$	
STEP input minimum low time	t_{SL}		$\max(t_{FILTS D}, t_{CLK}+20)$	100		ns
STEP input minimum high time	t_{SH}		$\max(t_{FILTS D}, t_{CLK}+20)$	100		ns
DIR to STEP setup time	t_{DSU}		20			ns
DIR after STEP hold time	t_{DSH}		20			ns
STEP and DIR spike filtering time *)	$t_{FILTS D}$	rising and falling edge	13	20	30	ns
STEP and DIR sampling relative to rising CLK input	t_{SDCLKH}	before rising edge of CLK input		$t_{FILTS D}$		ns

*) These values are valid with full input logic level swing, only. Asymmetric logic levels will increase filtering delay $t_{FILTS D}$, due to an internal input RC filter.

13.2 Changing Resolution

The TMC2209 includes an internal microstep table with 1024 sine wave entries to generate sinusoidal motor coil currents. These 1024 entries correspond to one electrical revolution or four fullsteps. The microstep resolution setting determines the step width taken within the table. Depending on the DIR input, the microstep counter is increased (DIR=0) or decreased (DIR=1) with each STEP pulse by the step width. The microstep resolution determines the increment respectively the decrement. At maximum resolution, the sequencer advances one step for each step pulse. At half resolution, it advances two steps. Increment is up to 256 steps for fullstepping. The sequencer has special provision to allow seamless switching between different microstep rates at any time. When switching to a lower microstep resolution, it calculates the nearest step within the target resolution and reads the current vector at that position. This behavior especially is important for low resolutions like fullstep and halfstep, because any failure in the step sequence would lead to asymmetrical run when comparing a motor running clockwise and counterclockwise.

EXAMPLES:

Fullstep: Cycles through table positions: 128, 384, 640 and 896 (45°, 135°, 225° and 315° electrical position, both coils on at identical current). The coil current in each position corresponds to the RMS-Value (0.71 * amplitude). Step size is 256 (90° electrical)

Half step: The first table position is 64 (22.5° electrical), Step size is 128 (45° steps)

Quarter step: The first table position is 32 (90°/8=11.25° electrical), Step size is 64 (22.5° steps)

This way equidistant steps result and they are identical in both rotation directions. Some older drivers also use zero current (table entry 0, 0°) as well as full current (90°) within the step tables. This kind of stepping is avoided because it provides less torque and has a worse power dissipation in driver and motor.

Step position	table position	current coil A	current coil B
Half step 0	64	38.3%	92.4%
Full step 0	128	70.7%	70.7%
Half step 1	192	92.4%	38.3%
Half step 2	320	92.4%	-38.3%
Full step 1	384	70.7%	-70.7%
Half step 3	448	38.3%	-92.4%
Half step 4	576	-38.3%	-92.4%
Full step 2	640	-70.7%	-70.7%
Half step 5	704	-92.4%	-38.3%
Half step 6	832	-92.4%	38.3%
Full step 3	896	-70.7%	70.7%
Half step 7	960	-38.3%	92.4%

See chapter 3.4 for resolution settings available in stand-alone mode.

13.3 MicroPlyer Step Interpolator and Stand Still Detection

For each active edge on STEP, MicroPlyer produces microsteps at 256x resolution, as shown in Figure 13.2. It interpolates the time in between of two step impulses at the step input based on the last step interval. This way, from 2 microsteps (128 microstep to 256 microstep interpolation) up to 256 microsteps (full step input to 256 microsteps) are driven for a single step pulse.

The step rate for the interpolated 2 to 256 microsteps is determined by measuring the time interval of the previous step period and dividing it into up to 256 equal parts. The maximum time between two microsteps corresponds to 2^{20} (roughly one million system clock cycles), for an even distribution of 256 microsteps. At 12 MHz system clock frequency, this results in a minimum step input frequency of roughly 12 Hz for MicroPlyer operation. A lower step rate causes a standstill event to be detected. At that frequency, microsteps occur at a rate of $(\text{system clock frequency})/2^{16} - 256$ Hz. When a stand still is detected, the driver automatically begins standby current reduction if selected by pin PDN.

Attention

MicroPlyer only works perfectly with a jitter-free STEP frequency.

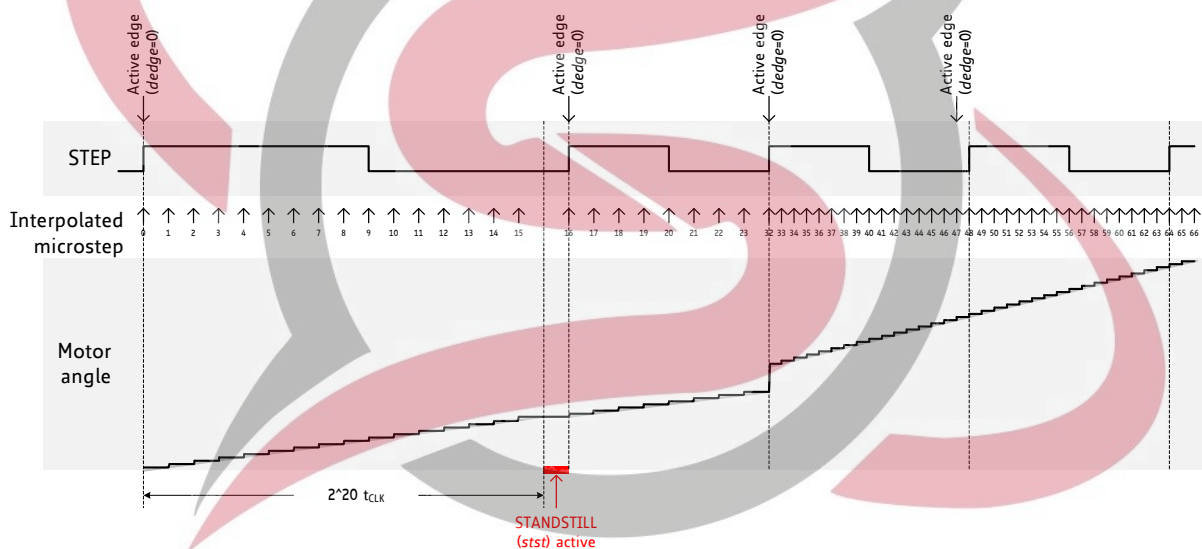

Figure 13.2 MicroPlyer microstep interpolation with rising STEP frequency (Example: 16 to 256)

In Figure 13.2, the first STEP cycle is long enough to set the *stst* bit standstill. Detection of standstill will enable the standby current reduction. This bit is cleared on the next STEP active edge. Then, the external STEP frequency increases. After one cycle at the higher rate MicroPlyer adapts the interpolated microstep rate to the higher frequency. During the last cycle at the slower rate, MicroPlyer did not generate all 16 microsteps, so there is a small jump in motor angle between the first and second cycles at the higher rate.

13.4 Index Output

An active INDEX output signals that the sine curve of motor coil A is at its positive zero transition. This correlates to the zero point of the microstep sequence. Usually, the cosine curve of coil B is at its maximum at the same time. Thus, the index signal is active once within each electrical period, and corresponds to a defined position of the motor within a sequence of four fullsteps. The INDEX output this way allows the detection of a certain microstep pattern, and thus helps to detect a position with more precision than a stop switch can do.

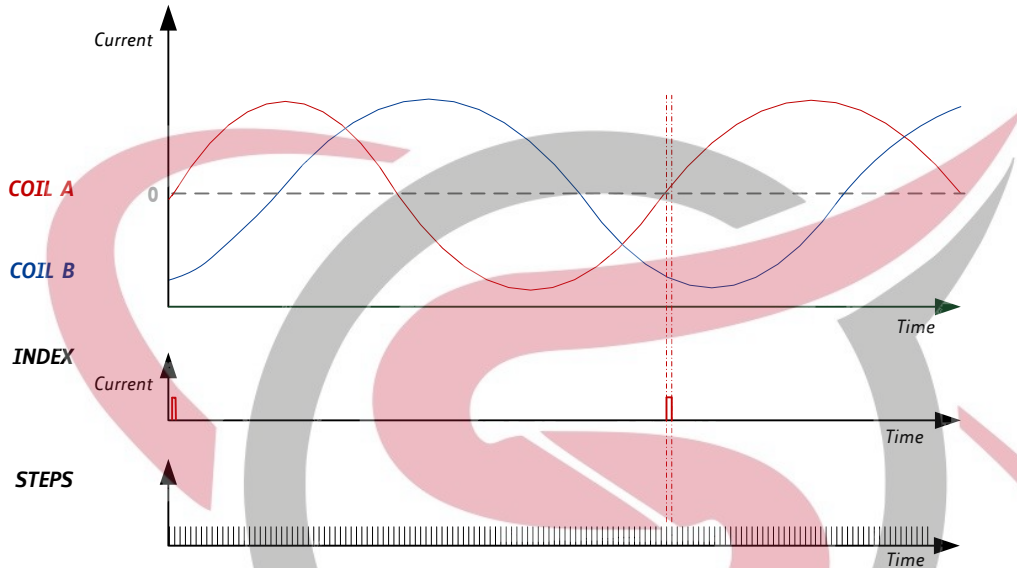

Figure 13.3 Index signal at positive zero transition of the coil A sine curve

Hint

The index output allows precise detection of the microstep position within one electrical wave, i.e. within a range of four fullsteps. With this, homing accuracy and reproducibility can be enhanced to microstep accuracy, even when using an inexpensive home switch.

SKYTECH
ELECTRONIC



14 Internal Step Pulse Generator

The TMC2209 family integrates a high-resolution step pulse generator, allowing motor motion via the UART interface. However, no velocity ramping is provided. Ramping is not required, if the target motion velocity is smaller than the start & stop frequency of the motor. For higher velocities, ramp up the frequency in small steps to accelerate the motor, and ramp down again to decelerate the motor. Figure 14.1 shows an example motion profile ramping up the motion velocity in discrete steps. Choose the ramp velocity steps considerably smaller than the maximum start velocity of the motor, because motor torque drops at higher velocity, and motor load at higher velocity typically increases.

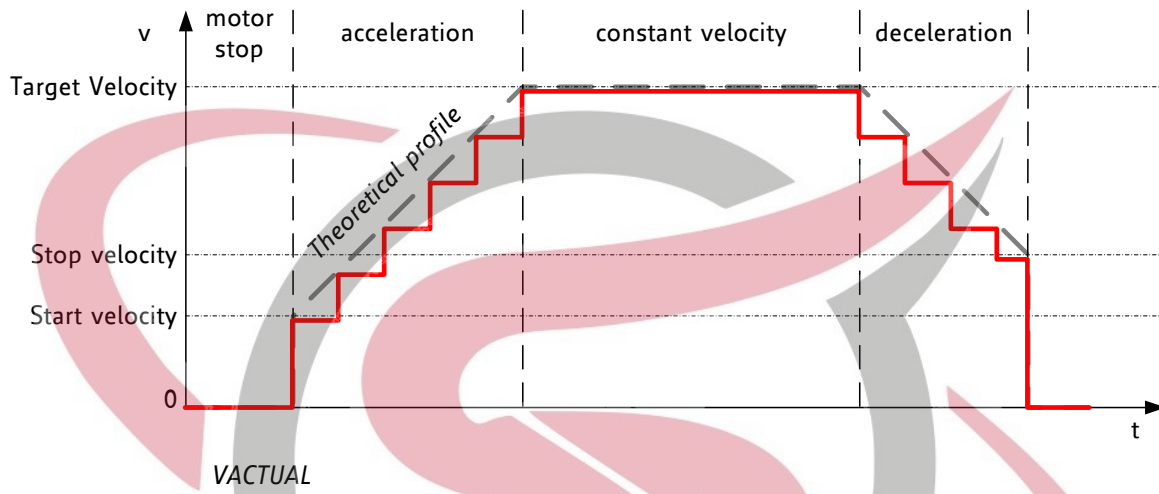

Figure 14.1 Software generated motion profile

PARAMETER VS. UNITS		
Parameter / Symbol	Unit	calculation / description / comment
f_{CLK} [Hz]	[Hz]	clock frequency of the TMC2209 in [Hz]
μ step velocity v [Hz]	μ steps / s	$v[\text{Hz}] = VACTUAL[2209] * (f_{CLK}[\text{Hz}]/2 / 2^{23})$ With internal oscillator: $v[\text{Hz}] = VACTUAL[2209] * 0.715\text{Hz}$
USC microstep count	counts	microstep resolution in number of microsteps (i.e. the number of microsteps between two fullsteps – normally 256)
rotations per second v [rps]	rotations / s	$v[\text{rps}] = v[\text{Hz}] / USC / FSC$ FSC: motor fullsteps per rotation, e.g. 200
$TSTEP$, $TPWMTHRS$	-	$TSTEP = f_{CLK} / f_{STEP}$ The time reference for velocity threshold is referred to the actual microstep frequency of the step input respectively velocity v [Hz].
$VACTUAL$	Two's complement signed internal velocity	$VACTUAL[2209] = (f_{CLK}[\text{Hz}]/2 / 2^{23}) / v[\text{Hz}]$ With internal oscillator: $VACTUAL[2209] = 0.715\text{Hz} / v[\text{Hz}]$

Hint

To monitor internal step pulse execution, program the INDEX output to provide step pulses ($GCONF.index_step$). It toggles upon each step. Use a timer input on your CPU to count pulses. Alternatively, regularly poll $MSCNT$ to grasp steps done in the previous polling interval. It wraps around from 1023 to 0.

15 Driver Diagnostic Flags

The TMC2209 drivers supply a complete set of diagnostic and protection capabilities, like short to GND protection, short to VS protection and undervoltage detection. A detection of an open load condition allows testing if a motor coil connection is interrupted. See the *DRV_STATUS* table for details.

15.1 Temperature Measurement

The driver integrates a four-level temperature sensor (pre-warning and thermal shutdown) for diagnostics and for protection of the IC against excess heat. The thresholds can be adapted by UART or OTP programming. Heat is mainly generated by the motor driver stages, and, at increased voltage, by the internal voltage regulator. Most critical situations, where the driver MOSFETs could be overheated, are avoided by the short to GND protection. For many applications, the overtemperature pre-warning will indicate an abnormal operation situation and can be used to initiate user warning or power reduction measures like motor current reduction. The thermal shutdown is just an emergency measure and temperature rising to the shutdown level should be prevented by design.

TEMPERATURE THRESHOLDS	
Overtemperature Setting	Comment
143°C (OTPW: 120°C)	Default setting. This setting is safest to switch off the driver stage before the IC can be destroyed by overheating. On a large PCB, the power MOSFETs reach roughly 150°C peak temperature when the temperature detector is triggered with this setting. This is a trip typical point for overtemperature shut down. The overtemperature pre-warning threshold of 120°C gives lots of headroom to react to high driver temperature, e.g. by reducing motor current.
150°C (OTPW: 120°C or 143°C)	Optional setting (OTP or UART). For small PCBs with high thermal resistance between PCB and environment, this setting provides some additional headroom. The small PCB shows less temperature difference between the MOSFETs and the sensor.
157°C (OTPW: 143°C)	Optional setting (UART). For applications, where a stop of the motor cannot be tolerated, this setting provides highest headroom, e.g. at high environment temperature ratings. Using the 143°C overtemperature pre-warning to reduce motor current ensures that the motor is not switched off by the thermal threshold.

Attention

Overtemperature protection cannot in all cases avoid thermal destruction of the IC. In case the rated motor current is exceeded, e.g. by operating a motor in StealthChop with wrong parameters, or with automatic tuning parameters not fitting the operating conditions, excess heat generation can quickly heat up the driver before the overtemperature sensor can react. This is due to a delay in heat conduction over the IC die.

After triggering the overtemperature sensor (*ot* flag), the driver remains switched off until the system temperature falls below the pre-warning level (*otpw*) to avoid continuous heating to the shutdown level.

15.2 Short Protection

The TMC2209 power stages are protected against a short circuit condition by an additional measurement of the current flowing through each of the power stage MOSFETs. This is important, as most short circuit conditions result from a motor cable insulation defect, e.g. when touching the conducting parts connected to the system ground. The short detection is protected against spurious triggering, e.g. by ESD discharges, by retrying three times before switching off the motor.

Once a short condition is safely detected, the corresponding driver bridge (A or B) becomes switched off, and the *s2ga* or *s2gb* flag, respectively *s2vsa* or *s2vsb* becomes set. In order to restart the motor, disable and re-enable the driver. Note, that short protection cannot protect the system and the power stages for all possible short events, as a short event is rather undefined and a complex network of external components may be involved. Therefore, short circuits should basically be avoided.



15.3 Open Load Diagnostics

Interrupted cables are a common cause for systems failing, e.g. when connectors are not firmly plugged. The TMC2209 detects open load conditions by checking, if it can reach the desired motor coil current. This way, also undervoltage conditions, high motor velocity settings or short and overtemperature conditions may cause triggering of the open load flag, and inform the user, that motor torque may suffer. In motor stand still, open load cannot always be measured, as the coils might eventually have zero current.

Open load detection is provided for system debugging.

In order to safely detect an interrupted coil connection, read out the open load flags at low or nominal motor velocity operation, only. If possible, use SpreadCycle for testing, as it provides the most accurate test. However, the *ola* and *olb* flags have just informative character and do not cause any action of the driver.

15.4 Diagnostic Output

The diagnostic output DIAG and the index output INDEX provide important status information. An active DIAG output shows that the driver cannot work normally, or that a motor stall is detected, when StallGuard is enabled. The INDEX output signals the microstep counter zero position, to allow referencing (homing) a drive to a certain current pattern. The function set of the INDEX output can be modified by UART.

Figure 15.1 shows the available signals and control bits.

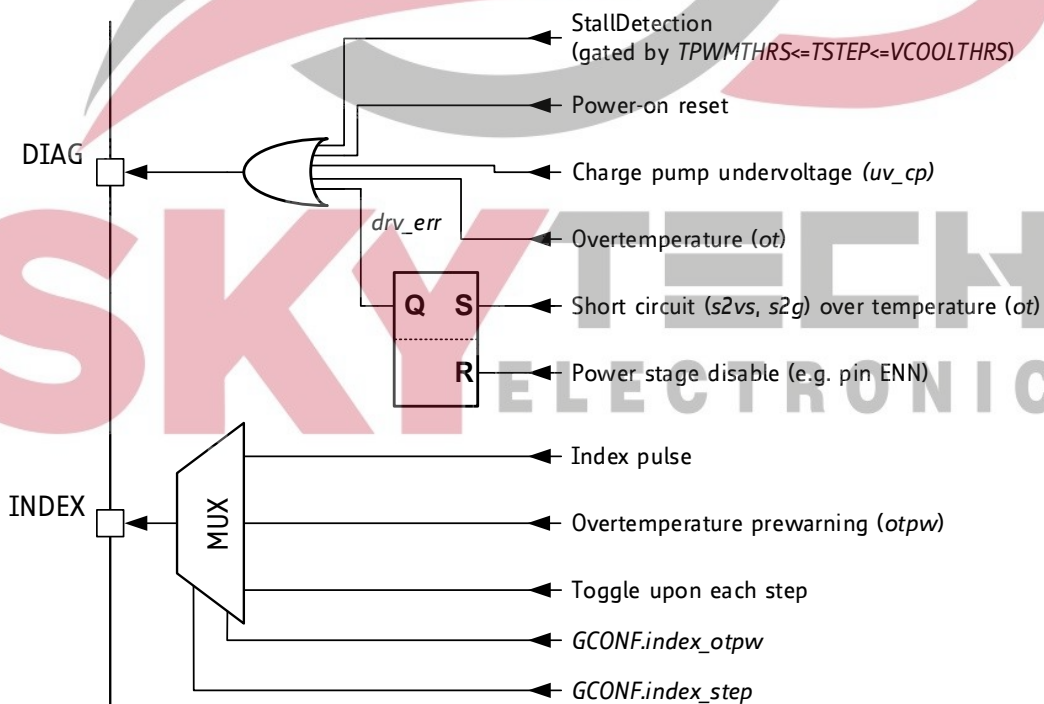

Figure 15.1 DIAG and INDEX outputs



16 Quick Configuration Guide

This guide is meant as a practical tool to come to a first configuration. Do a minimum set of measurements and decisions for tuning the driver to determine UART settings or OTP parameters. The flow-charts concentrate on the basic function set to make a motor run smoothly. Once the motor runs, you may decide to explore additional features, e.g. freewheeling in more detail. A current probe on one motor coil is a good aid to find the best settings, but it is not a must.

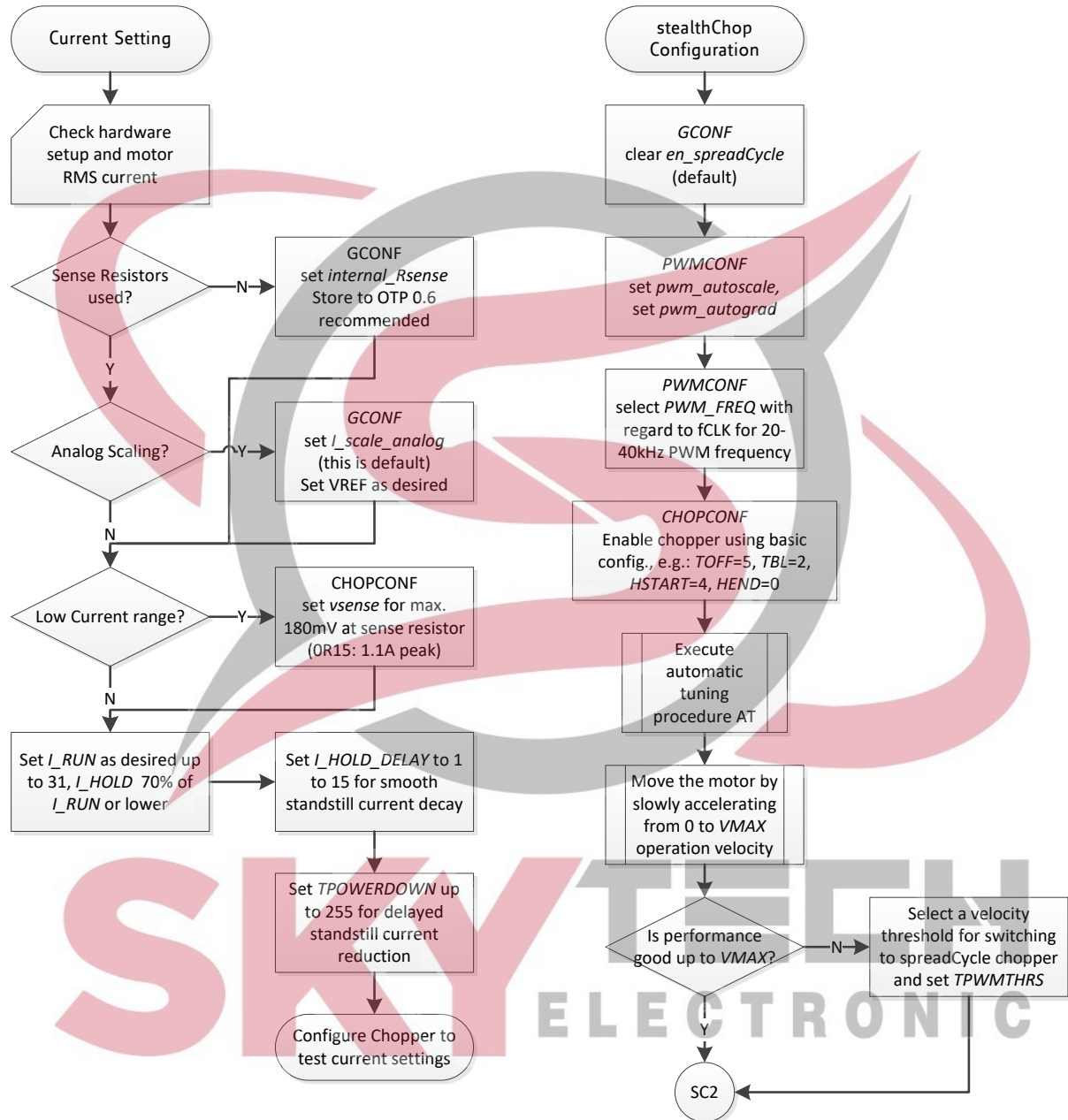

Figure 16.1 Current Setting and first steps with StealthChop

Hint

Use the evaluation board to explore settings and to generate the required configuration datagrams.

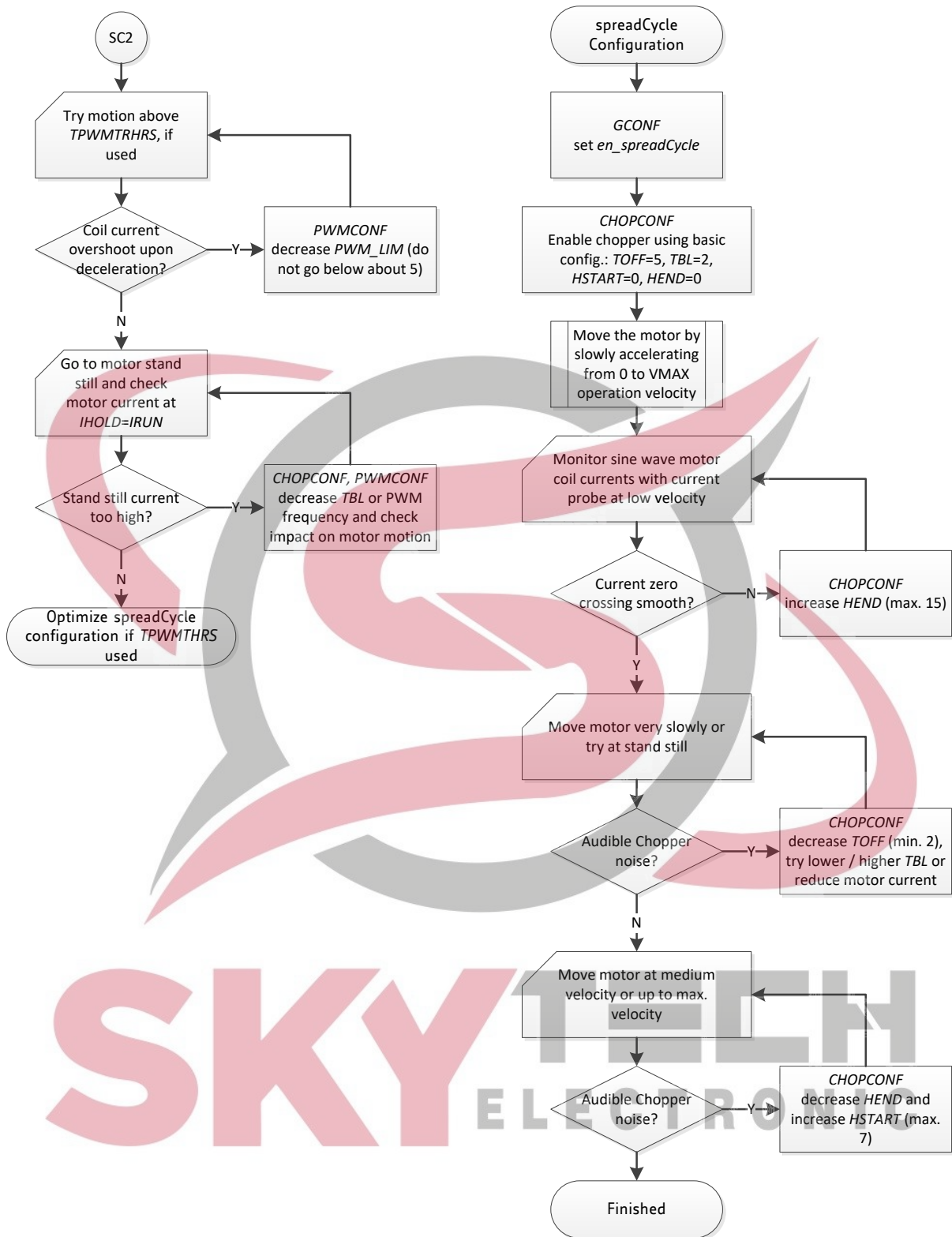

Figure 16.2 Tuning StealthChop and SpreadCycle

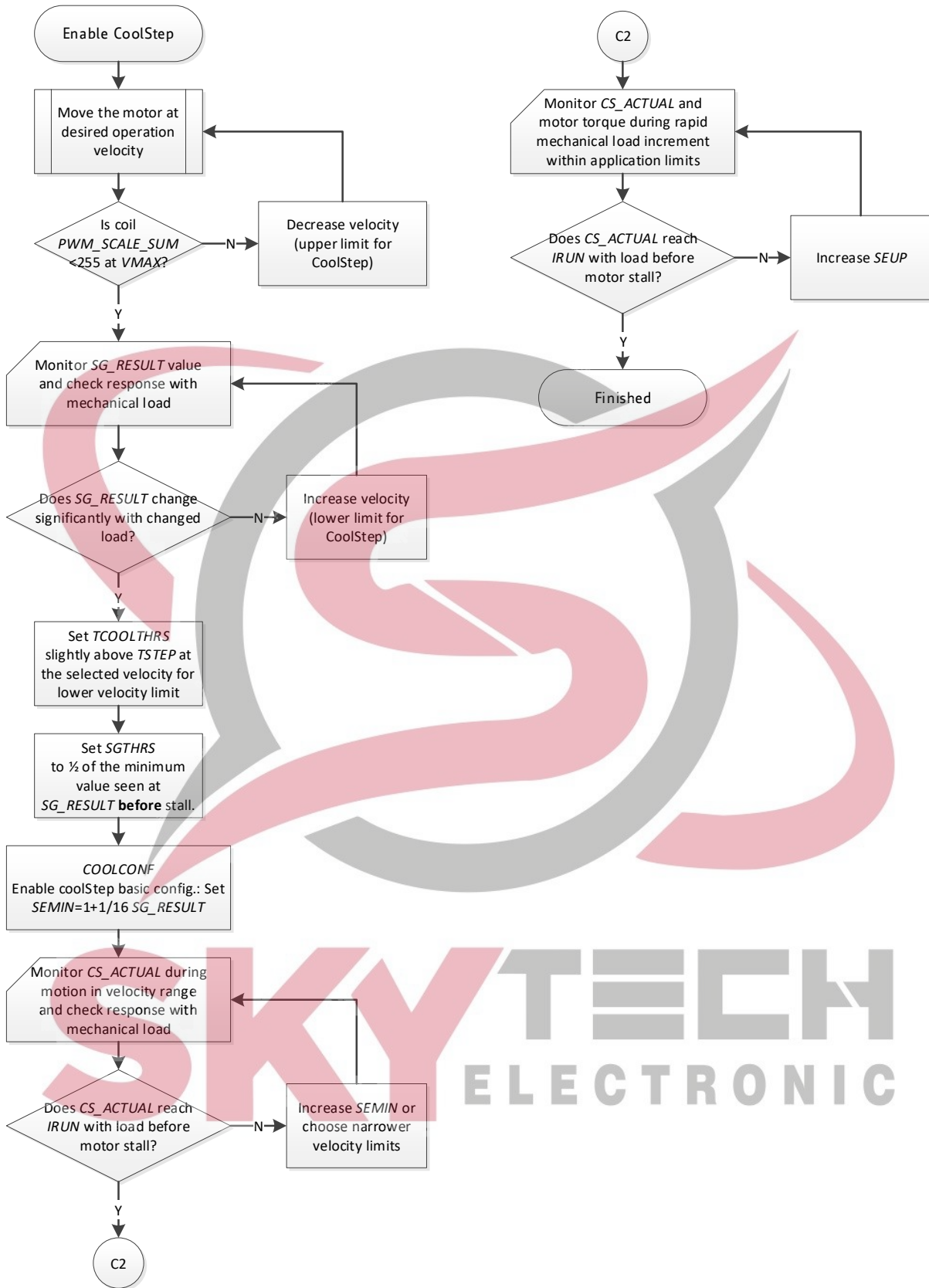

Figure 16.3 Configuration for CoolStep in StealthChop mode

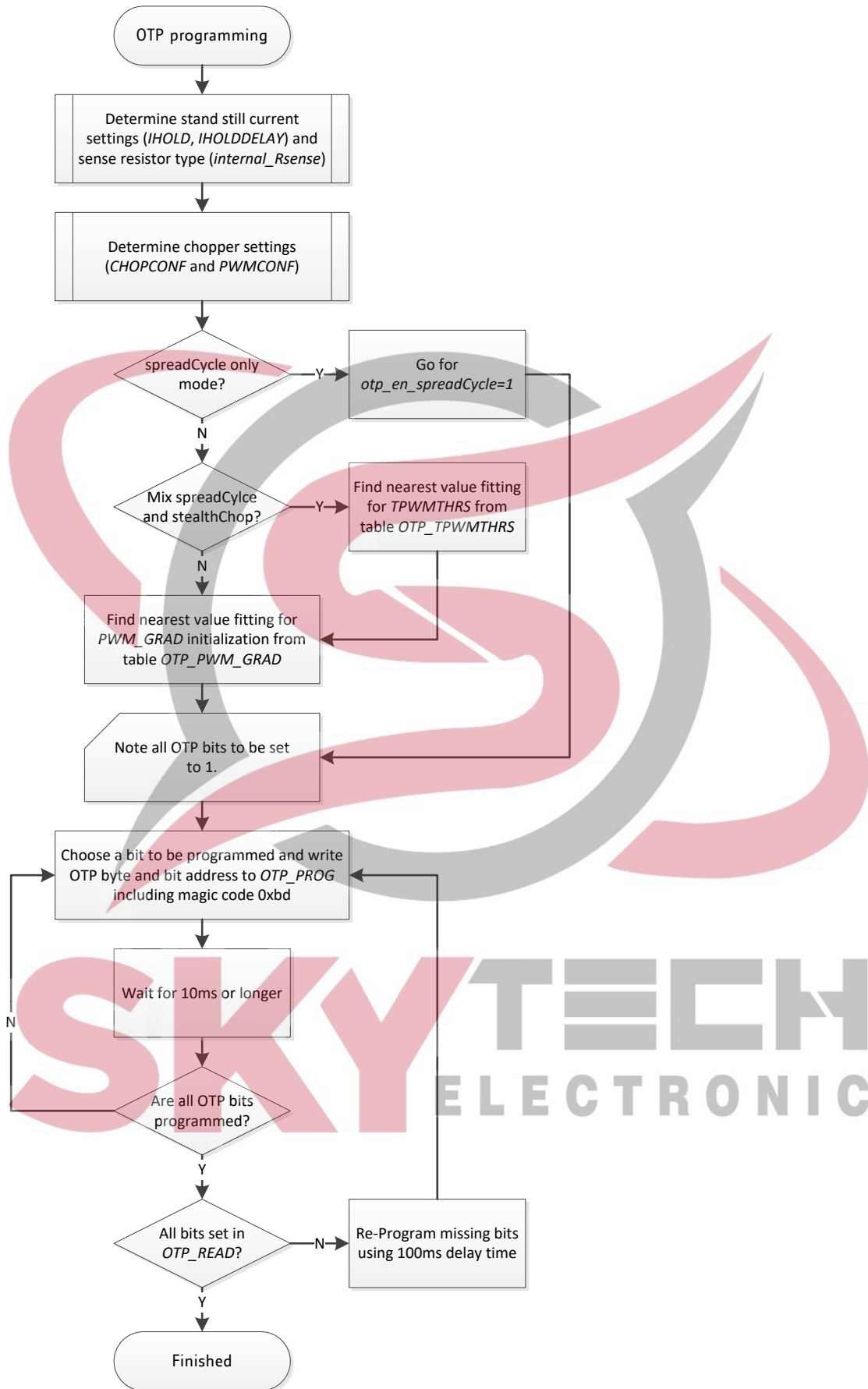

Figure 16.4 OTP programming

17 External Reset

The chip is loaded with default values during power on via its internal power-on reset. Some of the registers are initialized from the OTP at power up. In order to reset the chip to power on defaults, any of the supply voltages monitored by internal reset circuitry (VS, +5VOUT or VCC_IO) must be cycled. As +5VOUT is the output of the internal voltage regulator, it cannot be cycled via an external source except by cycling VS. It is easiest and safest to cycle VCC_IO in order to completely reset the chip. Also, current consumed from VCC_IO is low and therefore it has simple driving requirements. Due to the input protection diodes not allowing the digital inputs to rise above VCC_IO level, all inputs must be driven low during this reset operation. When this is not possible, an input protection resistor may be used to limit current flowing into the related inputs.

18 Clock Oscillator and Input

The clock is the timing reference for all functions: the chopper frequency, the blank time, the standstill power down timing, and the internal step pulse generator etc. The on-chip clock oscillator is calibrated in order to provide timing precise enough for most operation cases.

USING THE INTERNAL CLOCK

Directly tie the CLK input to GND near to the IC if the internal clock oscillator is to be used. The internal clock frequency is factory-trimmed to 12MHz by OTP programming.

USING AN EXTERNAL CLOCK

When an external clock is available, any frequency of 8 to 13.4MHz (max. 16MHz) can be used to clock the TMC2209. The duty cycle of the clock signal has to be near 50%, especially for high frequencies. Ensure minimum high or low input time for the pin (refer to electrical characteristics). Make sure, that the clock source supplies clean CMOS output logic levels and steep slopes when using a high clock frequency. The external clock input is enabled with the first positive polarity seen on the CLK input. Modifying the clock frequency is an easy way to adapt the StealthChop chopper frequency or to synchronize multiple drivers. Working with a very low clock frequency down to 4 MHz can help reducing power consumption and electromagnetic emissions, but it will sacrifice some performance.

Use an external clock source to synchronize multiple drivers, or to get precise motor operation with the internal pulse generator for motion. The external clock frequency selection also allows modifying the power down timing and the chopper frequency.

Hint

Switching off the external clock frequency would stop the chopper and could lead to an overcurrent condition. Therefore, TMC2209 has an internal timeout of 32 internal clocks. In case the external clock fails, it switches back to internal clock.

19 Absolute Maximum Ratings

The maximum ratings may not be exceeded under any circumstances. Operating the circuit at or near more than one maximum rating at a time for extended periods shall be avoided by application design.

Parameter	Symbol	Min	Max	Unit
Supply voltage operating with inductive load	V_{VS}	-0.5	32	V
Supply and bridge voltage max. *)	V_{VMAX}		33	V
I/O supply voltage	V_{VIO}	-0.5	5.5	V
digital supply voltage (when using external supply)	V_{5VOUT}	-0.5	5.5	V
Logic input voltage	V_I	-0.5	$V_{VIO}+0.5$	V
VREF input voltage (Do not exceed both, VCC_IO and 5VOUT by more than 10%, as this enables a test mode)	V_{VREF}	-0.5	6	V
Maximum current to / from digital pins and analog low voltage I/Os	I_{IO}		+/-10	mA
5V regulator output current (internal plus external load)	I_{5VOUT}		25	mA
5V regulator continuous power dissipation ($(V_{VM}-5V) * I_{5VOUT}$)	P_{5VOUT}		0.5	W
Power bridge repetitive output current	I_{Ox}		3	A
Junction temperature	T_J	-50	150	°C
Storage temperature	T_{STG}	-55	150	°C
ESD-Protection for interface pins in application (Human body model, HBM)	V_{ESDAP}		4	kV
ESD-Protection for handling (Human body model, HBM)	V_{ESD}		1	kV

*) Stray inductivity of GND and VS connections will lead to ringing of the supply voltage when driving an inductive load. This ringing results from the fast switching slopes of the driver outputs in combination with reverse recovery of the body diodes of the output driver MOSFETs. Even small trace inductivities as well as stray inductivity of sense resistors can easily generate a few volts of ringing leading to temporary voltage overshoot. This should be considered when working near the maximum voltage.

20 Electrical Characteristics

20.1 Operational Range

Parameter	Symbol	Min	Max	Unit
Junction temperature	T_J	-40	125	°C
Supply voltage (using internal +5V regulator)	V_{VS}	5.5	29	V
Supply voltage (using internal +5V regulator) for OTP programming	V_{VS}	6	29	V
Supply voltage (internal +5V regulator bridged: $V_{5VOUT}=V_{VS}$)	V_{VS}	4.7	5.4	V
I/O supply voltage	V_{VIO}	3.00	5.25	V
I/O supply voltage during standby	V_{VIO}	1.50	5.25	V
VCC voltage when using optional external source (supplies digital logic and charge pump)	V_{VCC}	4.6	5.25	V
RMS motor coil current per coil (value for design guideline)	I_{RMS}		1.4	A
RMS motor coil current per coil with duty cycle limit, e.g. 1s on, 1s standby (value for design guideline)	I_{RMS}		2.0	A
Peak output current per motor coil output (sine wave peak) using external or internal current sensing	I_{Ox}		2.8	A

20.2 DC and Timing Characteristics

DC characteristics contain the spread of values guaranteed within the specified supply voltage range unless otherwise specified. Typical values represent the average value of all parts measured at +25°C. Temperature variation also causes stray to some values. A device with typical values will not leave Min/Max range within the full temperature range.

Power supply current		DC-Characteristics				
		$V_{VS} = V_{VSA} = 24.0V$				
Parameter	Symbol	Conditions	Min	Typ	Max	Unit
Total supply current, standby	I_S	ENN=0V, VREF=0V		160	300	μA
Total supply current, driver disabled I_{VS}	I_S	$f_{CLK}=12MHz$		7	10	mA
Total supply current, operating, I_{VS}	I_S	$f_{CLK}=12MHz$, 35kHz chopper, no load		7.5		mA
Supply current, driver disabled, dependency on CLK frequency	I_{VS}	f_{CLK} variable, additional to I_{VS0}		0.3		mA/MHz
Internal current consumption from 5V supply on VCC pin	I_{VCC}	$f_{CLK}=12MHz$, 35kHz chopper		4.5		mA
IO supply current (typ. at 3.3V)	I_{VIO}	no load on outputs, inputs at V_{IO} or GND Excludes pull-down resistors		15	30	μA

Motor driver section		DC- and Timing-Characteristics				
		$V_{VS} = 24.0V$				
Parameter	Symbol	Conditions	Min	Typ	Max	Unit
RDS _{ON} lowside MOSFET	R_{ONL}	measure at 200mA, 25°C, static state		0.170	0.21	Ω
RDS _{ON} highside MOSFET	R_{ONH}	measure at 200mA, 25°C, static state		0.170	0.21	Ω
slope, MOSFET turning on	t_{SLPON}	measured at 700mA load current (resistive load)	35	60	150	ns
slope, MOSFET turning off	t_{SLPOFF}	measured at 700mA load current (resistive load)	35	60	150	ns
Current sourcing, driver off	I_{Oidle}	O_{XX} pulled to GND	120	180	250	μA

Charge pump		DC-Characteristics				
Parameter	Symbol	Conditions	Min	Typ	Max	Unit
Charge pump output voltage	$V_{VCP}-V_{VS}$	operating, typical $f_{chop}<40kHz$	4.0	$V_{VCC} - 0.22$	V_{VCC}	V
Charge pump voltage threshold for undervoltage detection	$V_{VCP}-V_{VS}$	using internal 5V regulator voltage	3.3	3.6	4.0	V
Charge pump frequency	f_{CP}			1/16 f_{CLKOSC}		

Linear regulator		DC-Characteristics				
$V_{VS} = V_{VSA} = 24.0V$						
Parameter	Symbol	Conditions	Min	Typ	Max	Unit
Output voltage	V_{5VOUT}	$I_{5VOUT} = 0mA$ $T_J = 25^{\circ}C$	4.80	5.0	5.25	V
Output resistance	R_{5VOUT}	Static load		1		Ω
Deviation of output voltage over the full temperature range	$V_{5VOUT(DEV)}$	$I_{5VOUT} = 5mA$ $T_J = \text{full range}$		+/-30	+/-100	mV
Deviation of output voltage over the full supply voltage range	$V_{5VOUT(DEV)}$	$I_{5VOUT} = 5mA$ $V_{VS} = \text{variable}$		+/-15	+/-30	mV / 10V

Clock oscillator and input		Timing-Characteristics				
Parameter	Symbol	Conditions	Min	Typ	Max	Unit
Clock oscillator frequency (factory calibrated)	f_{CLKOSC}	$t_J = -50^{\circ}C$		11.7		MHz
	f_{CLKOSC}	$t_J = 25^{\circ}C$	11.5	12.0	12.5	MHz
	f_{CLKOSC}	$t_J = 150^{\circ}C$		12.1		MHz
External clock frequency (operating)	f_{CLK}	Typ. at 40%/60% dutycycle, Max at 50% dutycycle	4	10-13.4	16	MHz
External clock high / low level time	t_{CLKH} / t_{CLKL}	CLK driven to $0.1 V_{VIO} / 0.9 V_{VIO}$	16			ns
External clock first pulse to trigger switching to external CLK	t_{CLKH} / t_{CLKL}	CLK driven high	30	25		ns
External clock timeout detection in cycles of internal f_{CLKOSC}	$X_{timeout}$	External clock stuck at low or high	32		48	cycles f_{CLKOSC}

SKYTECH
ELECTRONIC

Detector levels	DC-Characteristics					
Parameter	Symbol	Conditions	Min	Typ	Max	Unit
V _{VS} undervoltage threshold for RESET	V _{UV_VS}	V _{VS} rising	3.5	4.2	4.6	V
V _{5VOUT} undervoltage threshold for RESET	V _{UV_5VOUT}	V _{5VOUT} rising		3.5		V
V _{VCC_IO} undervoltage threshold for RESET	V _{UV_VIO}	V _{VCC_IO} rising (delay typ. 10µs)	2.1	2.55	3.0	V
V _{VCC_IO} undervoltage detector hysteresis	V _{UV_VIOHYST}			0.3		V
Short to GND detector threshold (V _{VS} - V _{OX})	V _{OS2G}		2	2.5	3	V
Short to VS detector threshold (V _{OX})	V _{OS2VS}		1.6	2	2.3	V
Short detector delay (high side / low side switch on to short detected)	t _{S2G}	High side output clamped to V _{SP} -3V	0.8	1.3	2	µs
Overtemperature prewarning 120°C	t _{OTPW}	Temperature rising	100	120	140	°C
Overtemperature shutdown or prewarning 143°C (appr. 153°C IC peak temp.)	t _{OT143}	Temperature rising	128	143	163	°C
Overtemperature shutdown 150°C (appr. 160°C IC peak temp.)	t _{OT150}	Temperature rising	135	150	170	°C
Overtemperature shutdown 157°C (appr. 167°C IC peak temp.)	t _{OT157}	Temperature rising	142	157	177	°C
Difference between temperature detector and power stage temperature, slow heat up	t _{OTDIFF}	Power stage causing high temperature, normal 4 Layer PCB		10		°C

Sense resistor voltage levels	DC-Characteristics f _{CLK} =16MHz					
Parameter	Symbol	Conditions	Min	Typ	Max	Unit
Sense input peak threshold voltage (low sensitivity)	V _{SRTL}	vsense=0 csactual=31 CUR_A/B=248 Hyst.=0; I _{BRxy} =0		325		mV
Sense input peak threshold voltage (high sensitivity)	V _{SRTH}	vsense=1 csactual=31 CUR_A/B=248 Hyst.=0; I _{BRxy} =0		180		mV
Sense input tolerance / motor current full scale tolerance -using internal reference	I _{COIL}	I _{scale_analog} =0, vsense=0	-5		+5	%
Sense input tolerance / motor current full scale tolerance -using external reference voltage	I _{COIL}	I _{scale_analog} =1, V _{AIN} =2V, vsense=0	-2		+2	%
Internal resistance from pin BRxy to internal sense comparator (additional to sense resistor)	R _{BRxy}			20		mΩ

Digital pins	DC-Characteristics					
Parameter	Symbol	Conditions	Min	Typ	Max	Unit
Input voltage low level	V_{INLO}		-0.3		$0.3 V_{VIO}$	V
Input voltage high level	V_{INHI}		$0.7 V_{VIO}$		$V_{VIO}+0.3$	V
Input Schmitt trigger hysteresis	V_{INHYST}			$0.12 V_{VIO}$		V
Output voltage low level	V_{OUTLO}	$I_{OUTLO} = 2mA$			0.2	V
Output voltage high level	V_{OUTH}	$I_{OUTH} = -2mA$	$V_{VIO}-0.2$			V
Input leakage current	I_{ILEAK}		-10		10	μA
Pullup / pull-down resistors	R_{PU}/R_{PD}		132	166	200	k Ω
Pull-down resistor STANDBY pin	R_{PD}		80	100	120	k Ω
Digital pin capacitance	C			3.5		pF

AIN/IREF input	DC-Characteristics					
Parameter	Symbol	Conditions	Min	Typ	Max	Unit
AIN_IREF input resistance to 2.5V (=5V _{OUT} /2)	R_{AIN}	Measured to GND (<i>internalRsense=0</i>)	260	330	400	k Ω
AIN_IREF input voltage range for linear current scaling	V_{AIN}	Measured to GND (<i>IScaleAnalog=1</i>)	0	0.5-2.4	$V_{5VOUT}/2$	V
AIN_IREF open input voltage level	V_{AINO}	Open circuit voltage (<i>internalRsense=0</i>)		$V_{5VOUT}/2$		V
AIN_IREF input resistance to GND for reference current input	R_{IREF}	Measured to GND (<i>internalRsense=1</i>)	0.3	0.45	0.60	k Ω
AIN_IREF current amplification for reference current to coil current at maximum setting	$I_{REFAMPL}$	$I_{IREF} = 0.25mA$		3000		Times
Motor current full-scale tolerance -using RDSon measurement (value for design guideline to calculate reproduction of certain motor current & torque)	I_{COIL}	<i>Internal_Rsense=1, vsense=0, I_{IREF} = 0.25mA (after reaching thermal balance)</i>	-10		+10	%

SKYTECH
ELECTRONIC

20.3 Thermal Characteristics

The following table shall give an idea on the thermal resistance of the package. The thermal resistance for a four-layer board will provide a good idea on a typical application. Actual thermal characteristics will depend on the PCB layout, PCB type and PCB size. The thermal resistance will benefit from thicker CU (inner) layers for spreading heat horizontally within the PCB. Also, air flow will reduce thermal resistance.

A thermal resistance of 30K/W for a typical board means, that the package is capable of continuously dissipating 3.3W at an ambient temperature of 25°C with the die temperature staying below 125°C. Note, that a thermally optimized layout is required.

Parameter	Symbol	Conditions	Typ	Unit
Typical power dissipation	P_D	StealthChop or SpreadCycle, 1.4A RMS in two phase motor, sinewave, 40 or 20kHz chopper, 24V, 90°C peak surface of package (motor QSH4218-035-10-027, short time operation)	2.8	W
Typical power dissipation	P_D	StealthChop or SpreadCycle, 1.0A RMS in two phase motor, sinewave, 40 or 20kHz chopper, 24V, 70°C peak surface of package (motor QSH4218-035-10-027)	1.4	W
Thermal resistance junction to ambient on a multilayer board QFN28	R_{TJA}	Dual signal and two internal power plane board (2s2p) as defined in JEDEC EIA JESD51-5 and JESD51-7 (FR4, 35µm CU, 70mm x 133mm, d=1.5mm)	30	K/W
Thermal resistance junction to case	R_{TJC}	Junction to heat slug of package	6	K/W

Table 20.1 Thermal characteristics TMC2209

Note

A spread-sheet for calculating TMC2209 power dissipation is available on www.trinamic.com.

21 Layout Considerations

21.1 Exposed Die Pad

The TMC2209 uses its die attach pad to dissipate heat from the drivers and the linear regulator to the board. For best electrical and thermal performance, use a reasonable amount of solid, thermally conducting vias between the die attach pad and the ground plane. The printed circuit board should have a solid ground plane spreading heat into the board and providing for a stable GND reference.

21.2 Wiring GND

All signals of the TMC2209 are referenced to their respective GND. Directly connect all GND pins under the device to a common ground area (GND and die attach pad). The GND plane right below the die attach pad should be treated as a virtual star point. For thermal reasons, the PCB top layer shall be connected to a large PCB GND plane spreading heat within the PCB.

Attention

Especially the sense resistors are susceptible to GND differences and GND ripple voltage, as the microstep current steps make up for voltages down to 0.5 mV. No current other than the sense resistor current should flow on their connections to GND and to the TMC2209. Optimally place them close to the IC, with one or more vias to the GND plane for each sense resistor. The two sense resistors for one coil should not share a common ground connection trace or vias, as also PCB traces have a certain resistance.

21.3 Supply Filtering

The 5VOUT output voltage ceramic filtering capacitor (2.2 to 4.7 μ F recommended) should be placed as close as possible to the 5VOUT pin, with its GND return going directly to the die pad or the nearest GND pin. This ground connection shall not be shared with other loads or additional vias to the GND plane. Use as short and as thick connections as possible.

The motor supply pins VS should be decoupled with an electrolytic capacitor (47 μ F or larger is recommended) and a ceramic capacitor, placed close to the device.

Take into account that the switching motor coil outputs have a high dV/dt . Thus capacitive stray into high resistive signals can occur, if the motor traces are near other traces over longer distances.

SKY **TECH**
ELECTRONIC

21.4 Layout Example TMC2209

Schematic

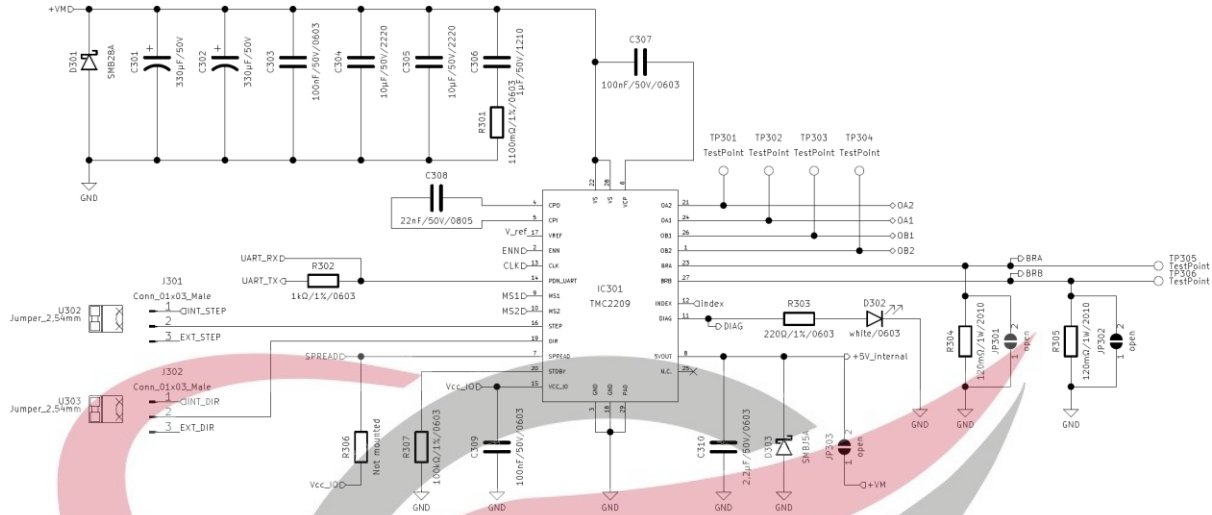

Placement (Excerpt)

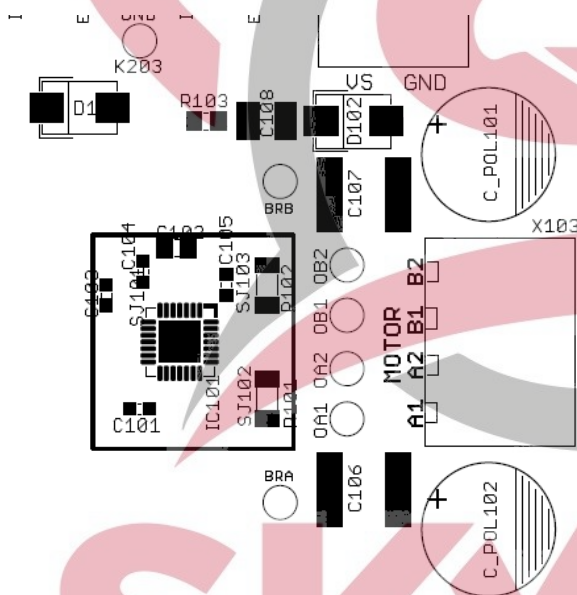

Top Layout (Excerpt, showing die pad vias)

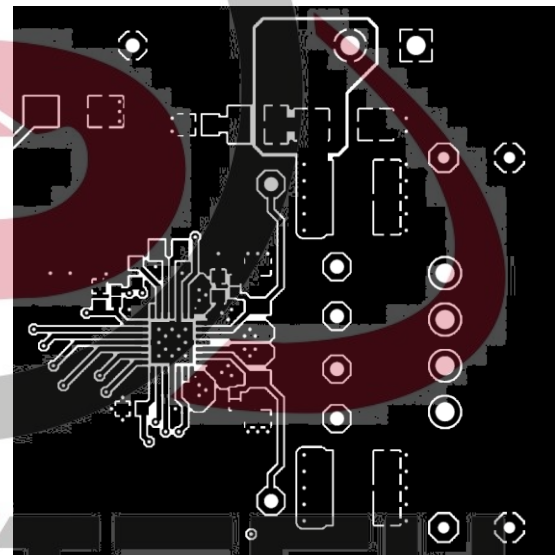

The complete schematics and layout data for all TMC2209 evaluation boards are available on the TRINAMIC website. Placement and layout show the more compact routing on TMC2208-EVAL

22 Package Mechanical Data

22.1 Dimensional Drawings QFN28

Attention: Drawings not to scale.

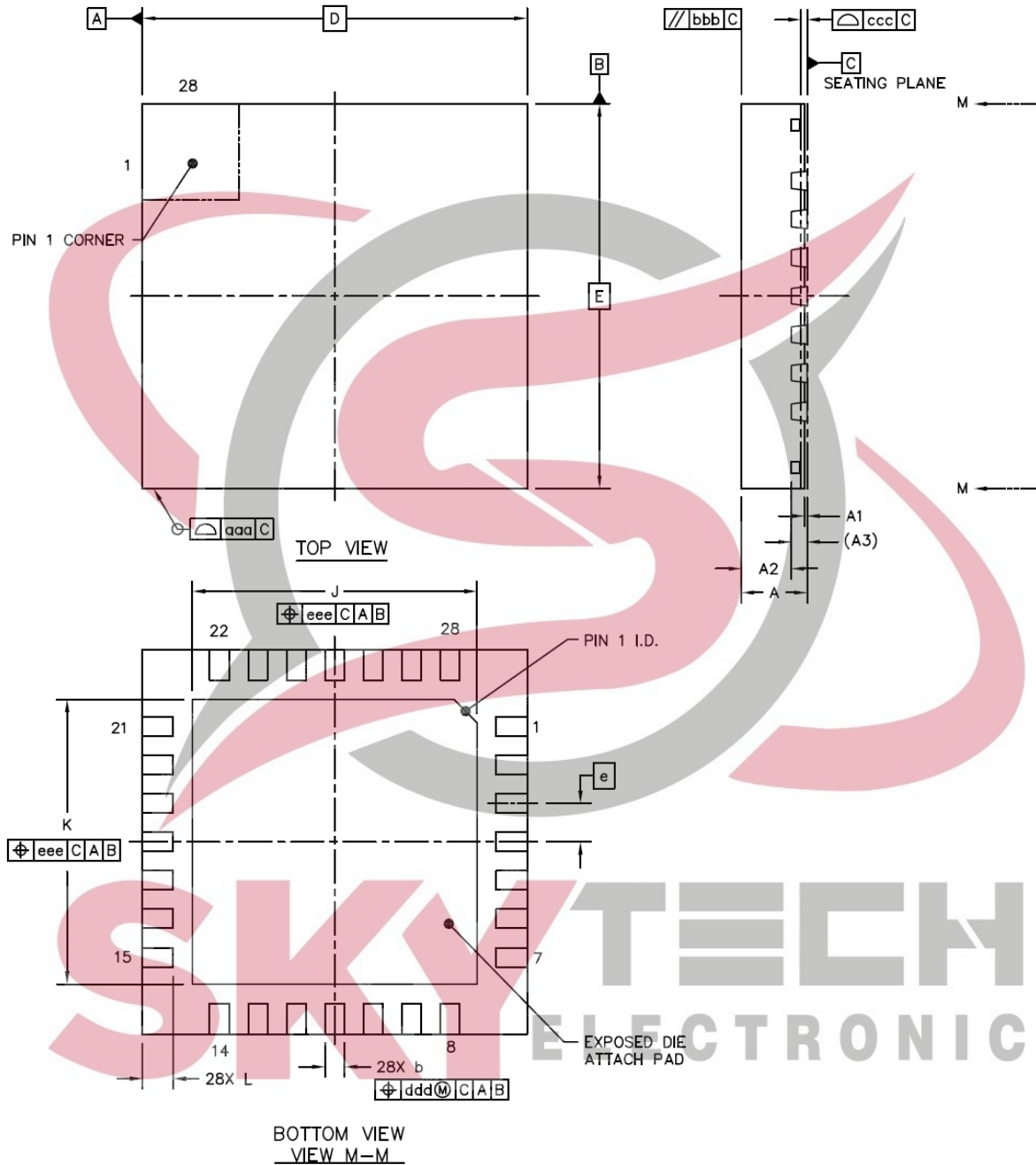

Figure 22.1 Dimensional drawings QFN28

Parameter	[mm]	Ref	Min	Nom	Max
total thickness		A	0.8	0.85	0.9
stand off		A1	0	0.035	0.05
mold thickness		A2		0.65	
lead frame thickness		A3		0.203	
lead width		b	0.2	0.25	0.3
body size X		D		5.0	
body size Y		E		5.0	
lead pitch		e		0.5	
exposed die pad size X *)		J	3.6	3.7	3.8
exposed die pad size Y *)		K	3.6	3.7	3.8
lead length *)		L	0.35	0.4	0.45
package edge tolerance		aaa			0.1
mold flatness		bbb			0.1
coplanarity		ccc			0.08
lead offset		ddd			0.1
exposed pad offset		eee			0.1

*) Attention: These parameters differ to TMC2208 package!

The TMC2209 has a bigger heat-slug than the TMC2208 for better power dissipation. Pad length is slightly shorter to match this.

22.2 Package Codes

Type	Package	Temperature range	Code & marking
TMC2209-LA	QFN28 (RoHS)	-40°C ... +125°C	TMC2209-LA
TMC... -T	-T suffix denotes tape on reel packed products		

SKYTECH
ELECTRONIC

23 Table of Figures

FIGURE 1.1 TMC2209 BASIC APPLICATION BLOCK DIAGRAM.....	4
FIGURE 1.2 STAND-ALONE DRIVER WITH PRE-CONFIGURATION.....	5
FIGURE 1.3 ENERGY EFFICIENCY WITH COOLSTEP (EXAMPLE)	7
FIGURE 1.4 AUTOMATIC MOTOR CURRENT POWER DOWN.....	8
FIGURE 2.1 TMC2209 PINNING TOP VIEW – TYPE: QFN28, 5X5MM ² , 0.5MM PITCH	9
FIGURE 3.1 STANDARD APPLICATION CIRCUIT.....	11
FIGURE 3.2 APPLICATION CIRCUIT USING RDSON BASED SENSING.....	12
FIGURE 3.3 5V ONLY OPERATION.....	12
FIGURE 3.4 SIMPLE ESD ENHANCEMENT AND MORE ELABORATE MOTOR OUTPUT PROTECTION	14
FIGURE 4.1 ATTACHING THE TMC2209 TO A MICROCONTROLLER UART	17
FIGURE 4.2 ADDRESSING MULTIPLE TMC2209 VIA SINGLE WIRE INTERFACE USING ANALOG SWITCHES	18
FIGURE 6.1 MOTOR COIL SINE WAVE CURRENT WITH STEALTHCHOP (MEASURED WITH CURRENT PROBE).....	35
FIGURE 6.2 STEALTHCHOP2 AUTOMATIC TUNING PROCEDURE	36
FIGURE 6.3 SCOPE SHOT: GOOD SETTING FOR PWM_REG	38
FIGURE 6.4 SCOPE SHOT: TOO SMALL SETTING FOR PWM_REG DURING AT#2	38
FIGURE 6.5 SUCCESSFULLY DETERMINED PWM_GRAD(AUTO) AND PWM_OFS(AUTO).....	38
FIGURE 6.6 VELOCITY BASED PWM SCALING (PWM_AUTOSCALE=0).....	40
FIGURE 6.7 TPWMTHRS FOR OPTIONAL SWITCHING TO SPREADCYCLE.....	41
FIGURE 7.1 CHOPPER PHASES	45
FIGURE 7.2 NO LEDGES IN CURRENT WAVE WITH SUFFICIENT HYSTERESIS (MAGENTA: CURRENT A, YELLOW & BLUE: SENSE RESISTOR VOLTAGES A AND B).....	47
FIGURE 7.3 SPREADCYCLE CHOPPER SCHEME SHOWING COIL CURRENT DURING A CHOPPER CYCLE.....	48
FIGURE 9.1 SCALING THE MOTOR CURRENT USING THE ANALOG INPUT.....	52
FIGURE 11.1 FUNCTION PRINCIPLE OF STALLGUARD4	55
FIGURE 12.1 COOLSTEP ADAPTS MOTOR CURRENT TO THE LOAD.....	58
FIGURE 13.1 STEP AND DIR TIMING, INPUT PIN FILTER	60
FIGURE 13.2 MICROPLYER MICROSTEP INTERPOLATION WITH RISING STEP FREQUENCY (EXAMPLE: 16 TO 256).....	62
FIGURE 13.3 INDEX SIGNAL AT POSITIVE ZERO TRANSITION OF THE COIL A SINE CURVE.....	63
FIGURE 14.1 SOFTWARE GENERATED MOTION PROFILE	64
FIGURE 15.1 DIAG AND INDEX OUTPUTS.....	66
FIGURE 16.1 CURRENT SETTING AND FIRST STEPS WITH STEALTHCHOP.....	67
FIGURE 16.2 TUNING STEALTHCHOP AND SPREADCYCLE	68
FIGURE 16.3 CONFIGURATION FOR COOLSTEP IN STEALTHCHOP MODE.....	69
FIGURE 16.4 OTP PROGRAMMING	70
FIGURE 22.1 DIMENSIONAL DRAWINGS QFN28.....	80



24 Revision History

Version	Date	Author	Description
V0.05	2018-Dec-04	BD BD= Bernhard Dwersteg	Preliminary work
V0.06	2019-Feb-04	BD	Updated electrical data as measured on samples
V0.1	2019-Feb-11	BD	Finished preliminary datasheet
V0.90	2019-Feb-12	BD	Standby current, new Eval-Board added
V1.00	2019-Feb-28	BD	Hints for coolStep
V1.01	2019-Apr-26	BD	Corrected table of microstep pin settings
V1.02	2019-May-14	BD	Relaxed spec concerning voltage limit up to 33V
V1.03	2019-Jun-25	BD	Hint for StealthChop IRUN must be >=8

Table 24.1 Document Revisions

25 References

[TMC2209-EVAL] TMC22xx Evaluation board: Manuals, software and PCB data available on www.trinamic.com

[AN001] Trinamic Application Note 001 - Parameterization of SpreadCycle™, www.trinamic.com

Calculation sheet TMC2209_Calculations.xlsx www.trinamic.com



SKYTECH
ELECTRONIC